

The ROOF

is on FIRE

Science, Art, and Music

Let the

HOLY GHOST BURN



$(-24)$   $32$   $32$   $32$   $H4$

$H4 + H4 = E8$

$(-24)$   $32$   $32$   $32$   $H4$

$F4$   $B4$   $D4$

$9 + 7 = 16 = U(2,2)$

$D4$   
Lullu CP2  
M4 x CP2

$3 + 9 = 12 = SU(2) \times U(3)$

$D4$   
Lullu CP2  
CP2 x M4

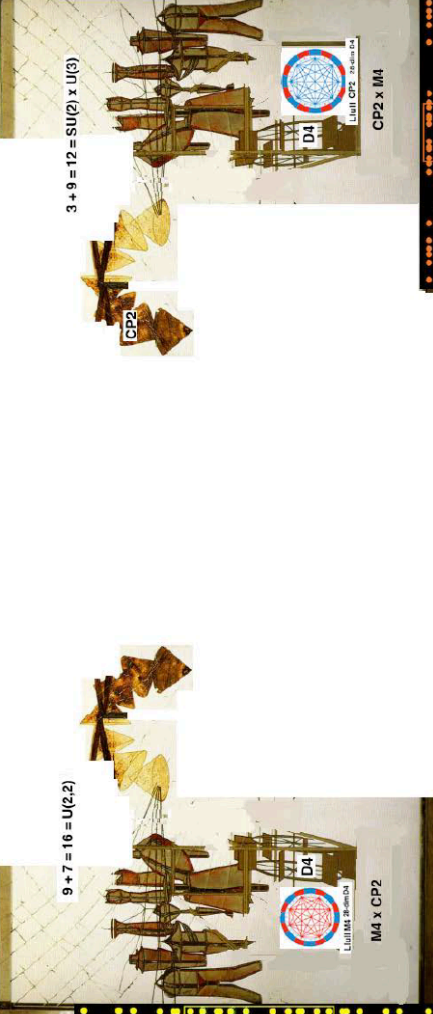
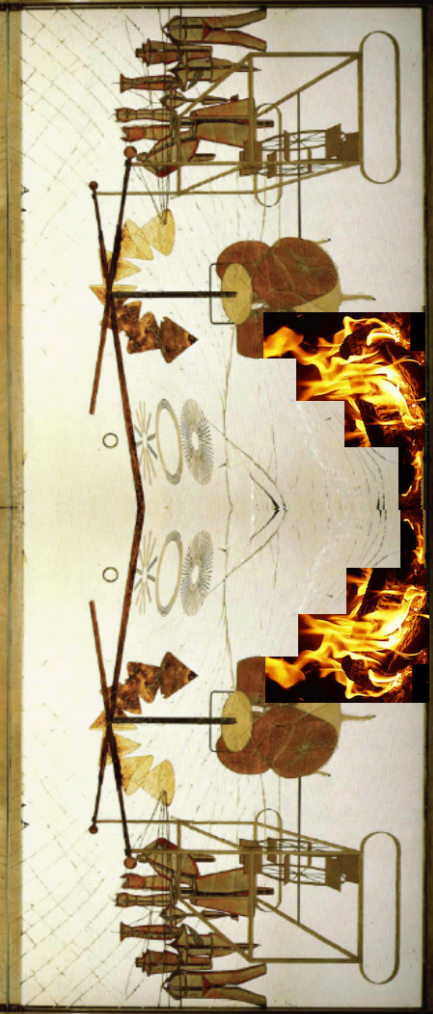

# Science, Art, and Music

Frank Dodd (Tony) Smith, Jr. - 2019

## Abstract

**In my view: Science = Art = Music:**

**Science is explained by a Theory of Everything (TOE) using Real Clifford Algebra  
CI(16)**

**The Pinnacle of Human Art is Marcel Duchamp's Large Glass which (when  
combined with its Mirror image) corresponds in detail with CI(16) Physics TOE**

**The Pinnacle of Human Music is Beethoven's Grosse Fugue which  
corresponds in detail with CI(16) TOE**

CI(16) emerged from a Quantum Fluctuation in a Void in our Parent Universe  
by **David Finkelstein's Clifford Iteration Process:**

**CI(Void) = Clifford Algebra of Void = 0**

**CI(0) =  $2^0$  dimensions = 1**

**CI(1) =  $2^1 = 2$**

**CI(2) =  $2^2 = 4$**

**CI(4) =  $2^4 = 16$**

**CI(16) =  $2^{16} = 65,536 = \text{tensor product CI}(8) \times \text{CI}(8) = 256 \times 256$**

CI(16) has 16 Vectors = Lie Ball = Spin(10) / Spin(8) x U(1)

CI(16) has 120 BiVectors = D8 subalgebra of E8

CI(16) has 128 half-Spinors ( 1 0-Vector + 126 8-Vectors + 1 16-Vector )

$120+128 = 248 = E8$

CI(16) has 560 TriVectors = 10 copies of Fr3(O)

56-dim Fr3(O) has 2 copies of 27-dim J3(O)

The other  $65,536-16-120-128-560 = 64,712$  elements of CI(16) are available  
to carry information in processes such as Quantum Consciousness.

**This paper is an Overview. For details see viXra 1810.0365 and 1904.0193  
and my other viXra papers and my pages on the web.**

## Table of Contents

Large Glass + Mirror represents CI(16) Physics  
with CI(16) emergence from Void by Clifford Iteration ... page 3

IFA and Ramon Llull X-wheel ... page 4

Beethoven Grosse Fugue ... page 5

## Table of Contents (cont'd)

### LGL+M Structure Sequence

D4 x D4 in Octonionic Spacetime ... page 8

Quaternionic M4 x CP2 Kaluza-Klein Spacetime

D4 for Gravity+Dark Energy with  $9+7 = 16$ -dim  $U(2,2)$

D4 for Standard Model with  $3+8 = 12$ -dim  $SU(3) \times SU(2) \times U(1)$

with  $SU(2) \times U(1)$  coming from  $CP2 = SU(3) / SU(2) \times U(1)$  ... page 9

D4 -> B4 -> F4 -> H4 ... page 10

H4 + H4 = 240 E8 Root Vectors - E8 = 248 **Cl(16) BiVectors + half-Spinors** ... page 11

Aschheim 2-dim image of E8 Root Vectors ... page 12

16 **Cl(16) Vectors** = Lie Ball  $Spin(10) / Spin(8) \times U(1)$  ... page 14

16 **Cl(16) Vectors** and 248 **Cl(16) BiVectors + half-Spinors** ... page 18

560 **Cl(16) TriVectors** = 10 copies of 56-dim  $Fr_3(O)$  ... page 19

26D Strings=World-Lines - Bohm Quantum Potential

Conscious Smiling Spirit Being ... page 20

Overview of LG+M and Cl(16) ... page 29

### Appendices

E8 Lagrangian Density and Cl(16) Vector Base Manifold ... page 30

Octonionic to Quaternionic Transition ... page 35

Schwinger Sources and Calculations of Forces, Particle Masses, etc .... page 40

Results of Calculations ... page 47

Cl(1,25) Algebraic Quantum Field Theory with Cl(16) symmetry ... page 49

Bohm Quantum Potential and Quantum Consciousness ... page 51

## Large Glass + Mirror represents Cl(16) Physics

Marcel Duchamp's Large Glass, when combined with its Mirror Image - LG+M -

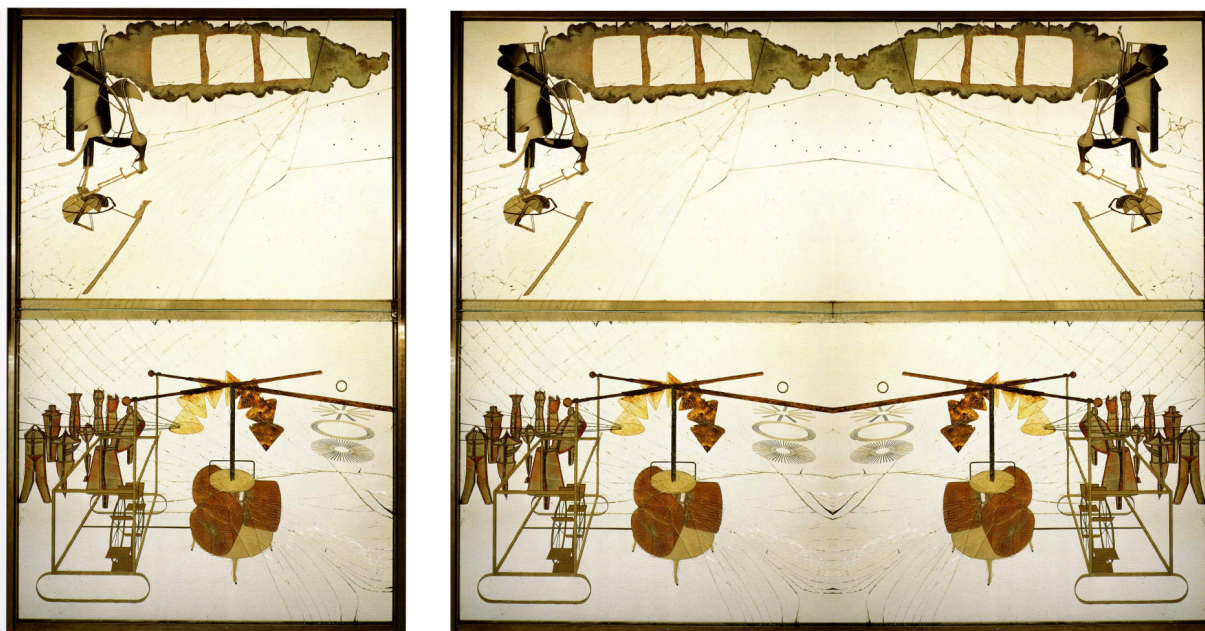

seems to contain the basic elements of a Theory of Everything ( TOE )  
based on Real Clifford Algebra Cl(16) ( viXra 1809.01670 and 1810.0365 ).  
Cl(16) emerged from a Quantum Fluctuation in a Void in our Parent Universe  
by David Finkelstein's Clifford Iteration Process

**Cl(Void) = Clifford Algebra of Void = 0**

**Cl(0) = 2<sup>0</sup> dimensions = 1**

**Cl(1) = 2<sup>1</sup> = 2**

**Cl(2) = 2<sup>2</sup> = 4**

**Cl(4) = 2<sup>4</sup> = 16**

**Cl(16) = 2<sup>16</sup> = 65,536**

which stops at Cl(16) because, by 8-Periodicity of Real Clifford Algebras,  
Cl(16) factors into tensor product Cl(8) x Cl(8)

LG+M represents the two 256-dim Cl(8) by two 8-paddle Wheels



**Duchamp 8-paddle Wheels**

represent

**Cl(8) Clifford Algebras**



Each Cl(8) contains 28-dim D4 Lie Algebra as its BiVectors.

**600 years before Duchamp, Ramon Llull represented D8 BiVector Lie Algebra of  $Cl(16)$  by his X-wheel with 16 vertices and 120 lines.** Lull had studied African divination systems and his choice of 16 vertices corresponded to 16 Orishas (8+8  $Cl(8)$  Spinors) and 256 Odu (16x16 Matrices of  $Cl(8)$ ) of ancient African IFA (viXra 0907.0040).

X-wheel's 120 lines are two sets of 28 lines for two D4 and

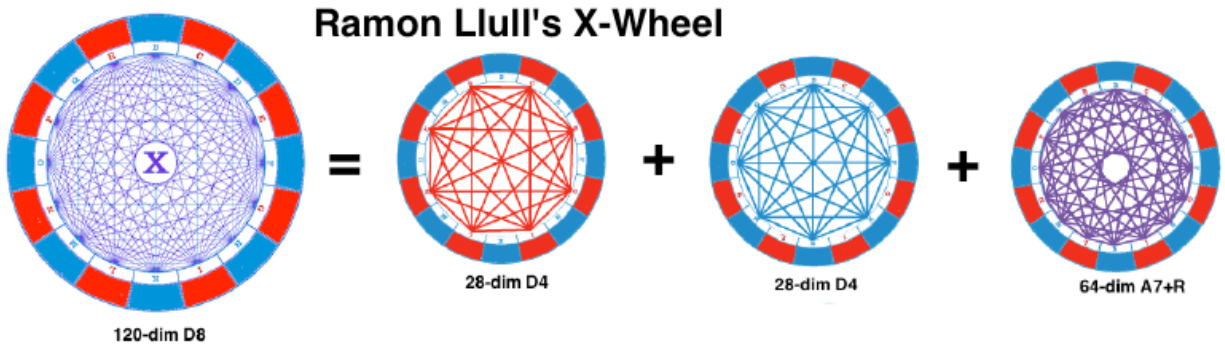

64 lines for A7+R that represent Creation / Annihilation Operators for 8-dim Spacetime whose 8-dim Octonionic Vector Space has Quaternionic substructure that is manifested at the End of Inflation as  $M4 \times CP2$  Kaluza-Klein where  $M4$  is 4-dim Physical Spacetime and  $CP2 = SU(3) / SU(2) \times U(1)$

The LG+M 8 paddle Wheel on the left has 28-dim D4 BiVectors with Conformal  $U(2,2)$  subalgebra containing  $D3 = Spin(2,4)$  giving Gravity + Dark Energy and acting on  $M4$  of  $M4 \times CP2$ .

The LG+M 8 paddle Wheel on the right has 28-dim D4 BiVectors with  $A3 = SU(4)$  subalgebra containing  $SU(3)$  giving the Standard Model and acting on  $CP2$  of  $M4 \times CP2$ .  $SU(2) \times U(1)$  of the Standard Model come from  $CP2 = SU(3) / SU(2) \times U(1)$ .

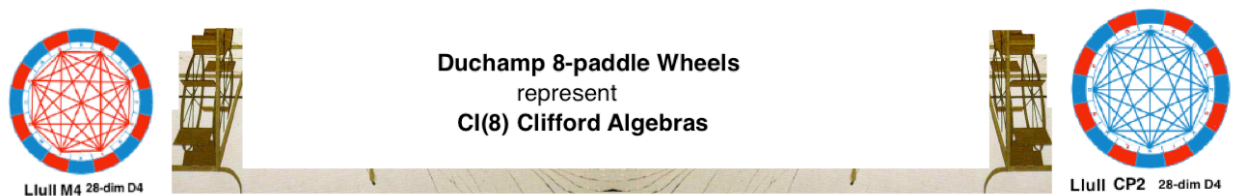

Anthony Bonner in his book Doctor Illuminatus about Llull said "... Even ...[Llull's]... disciple, le Myesier, complained ... about "... its sixteen figures, which confounded the mind." ... Llull ... tr[ie]d to persuade the Parisian schoolmen ...[but]... In 1390 ... the Faculty of Theology publish[ed] an edict prohibiting the teaching of Llullist doctrines ... [therefore]... As a result of the "weakness of human intellect" [of Parisian schoolmen] the number of figures [wa]s reduced and the algebraic notation vanishe[d] ...".

**100 years before Duchamp, Ludwig van Beethoven wrote the Grosse Fugue whose [Opening and Overture](#) represent the basic structure of Cl(16) Physics.**

Beethoven's Grosse Fugue (Opus 133 and 134) to me ( viXra 1901.0013 ) is the highest point in Human Music. Stephen Malinowski said "... many think ... Beethoven's late quartets are ... among civilization's crowning achievements ... and the Grosse Fuga arguably the most complex and challenging movement ...".

"... Since ... the 1920s ... the fugue has grown greatly in the eyes of musicians and performers. **"The Great Fugue... now seems to me the most perfect miracle in music,"** said Igor Stravinsky "... It is also the most absolutely contemporary piece of music I know, and contemporary forever... Hardly birthmarked by its age, the Great Fugue is, in rhythm alone, more subtle than any music of my own century... I love it beyond everything." Pianist Glenn Gould said, "for me, **the 'Grosse Fuge' is not only the greatest work Beethoven ever wrote but just about the most astonishing piece in musical literature.**" ...". (from Wikipedia)

My view is that **Duchamp's Large Glass + its Mirror image is to Art what Beethoven's Grosse Fugue is to Music**

and

that both of them are representations of Cl(16) Physics ( viXra 1804.0121 )

The Structure of Beethoven's Grosse Fugue (Opus 133 and 134)

( viXra 1901.0013 ) corresponds to Cl(16) - E8 Physics (viXra 1810.0365).

Since Beethoven wrote the Grosse Fugue in 1825, two years before his death in 1827, and the E8 Lie Algebra and the Cl(16) Real Clifford Algebra were not known until the work of Lie, Killing, and Clifford in the 1870s-1880s, it was not possible for Beethoven to have used the math knowledge of his day in writing the Grosse Fugue. A possible explanation could be that our conscious brains have structure similar to the structure of Cl(16) - E8 so that when Beethoven was composing, looking deep inside his conscious brain to "hear" music mentally that he could not hear normally because of his deafness, he was "seeing" Cl(16) - E8. Human quantum consciousness is based on microtubules containing maximally about 65,536 Tubulin Dimers. E8 lives in the 65,536-dimensional Real Clifford Algebra Cl(16). Cl(16) is the basic structure of our Universe so Beethoven could have been "seeing" in his mind that the E8 inside Cl(16) looks like part of the structure of microtubules of his consciousness and then writing that structure into the Grosse Fugue.

The Grosse Fugue correspondences with Cl(16) - E8 are shown here using visualizations by Stephen Malinowski.

Beethoven wrote String Quartet Opus 135 in 1826, the year after writing the Grosse Fugue and the year before his death. Its last movement is headed “Der schwer gefasste Entschluss” (“The Difficult Decision”). In it Beethoven wrote in the manuscript “Muss es sein?” (Must it be?) to which he responds “Es muss sein!” (It must be?). (Wikipedia)

### Der schwer gefasste Entschluss.



(Elias String Quartet - The Beethoven Project)

My view is that Beethoven sees that the Grosse Fugue has the deep theoretical / historical correlations that I describe in this paper and that he is asking himself to make the Difficult Decision of whether or not those correspondences made it inevitable that he write the Grosse Fugue as he did write it and continue to support it despite the fierce dislike of it expressed by his audience and his publisher. His answer “Es muss sein!” is a declaration that the Grosse Fugue is as important and accurate as to theory and history as I think it is.

### The Grosse Fugue [Opening and Overture](#) is

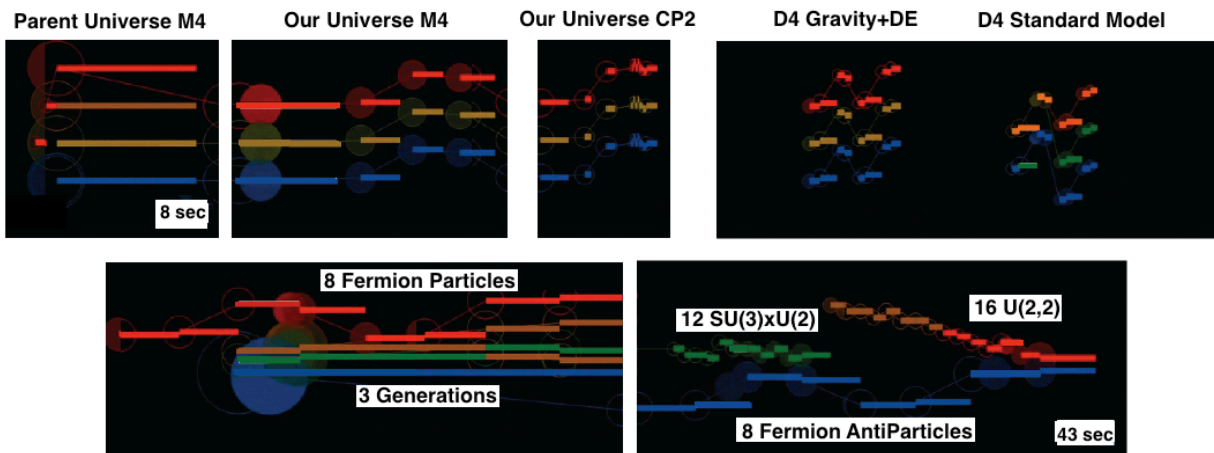

The two D4 of the D8 in E8 in Cl(16) are

D4 Gravity+Dark Energy

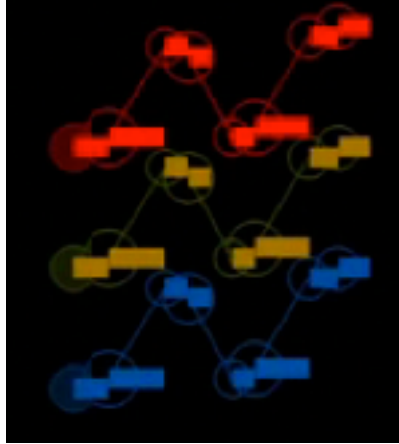

D4 Standard Model

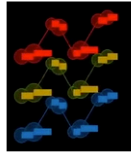
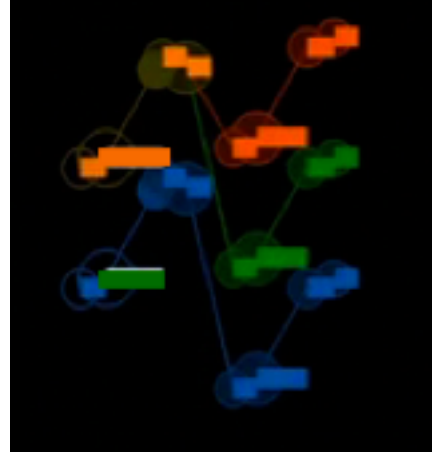

Duchamp 8-paddle Wheels  
represent  
Cl(8) Clifford Algebras

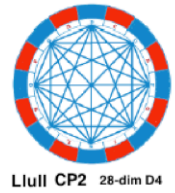
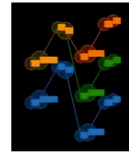

"... The Grosse Fugue ... was universally condemned by contemporary critics ... the audience had demanded encors of two middle movements ... Beethoven ... growled, "And why didn't they encore the Fugue? That alone should have been repeated! Cattle! Asses!" ...

the notoriously stubborn **Beethoven agreed ... readily to replace the fugue ..."**

just as **Lull had reduced the number of vertices of his X-wheel due to his perception of the "weakness of human intellect" ..."**.



# LGL+M = CI(16) Structure Sequence

Start with the two CI(8) of Periodicity tensor product  $CI(8) \times CI(8) = CI(16)$   
 Each CI(8) contains one of the two D4 subalgebras of the CI(16) BiVector Lie algebra D8



or equivalently  
 the two 8-vertex subwheels of Lull's 16-vertex X-wheel



or equivalently  
 these two passages from Beethoven's Grosse Fugue



Octonion Spacetime breaks into Quaternionic Kaluza-Klein  $M4 \times CP2 = SU(3) / U(2)$   
 at End of Inflation  
 with D4 of M4 for Gravity + Dark Energy and D4 of CP2 for Standard Model

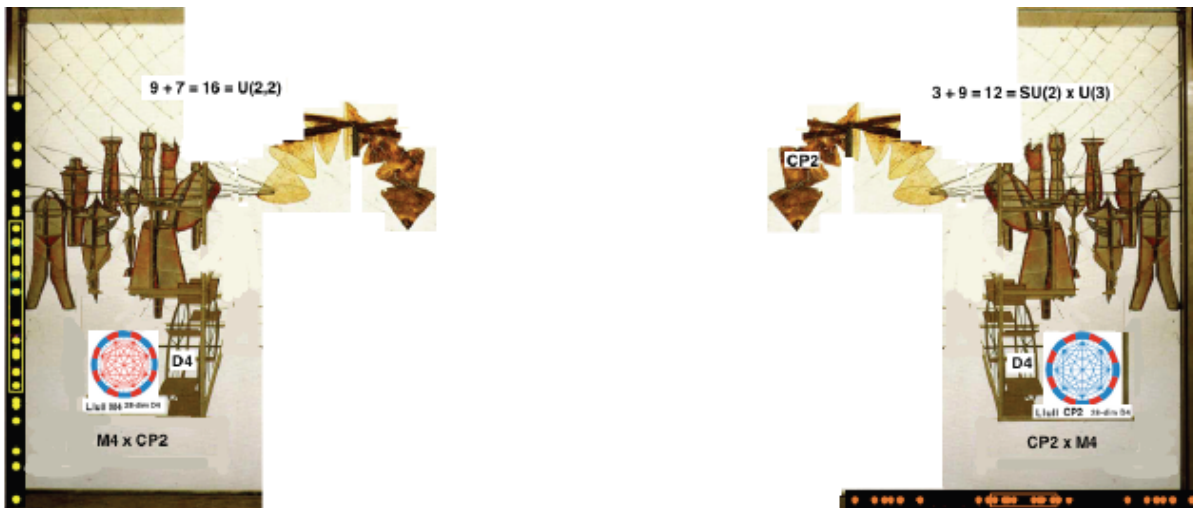

The Left D4 of Gravity + Dark Energy contains  $9+7=16$ -dim  $U(2,2)$   
 The Right D4 of Standard Model contains  $3+9=12$ -dim  $SU(3) \times SU(2) \times U(1)$   
 with the the  $16-12 = 4$  remaining representing  $CP2$   
 and  $SU(2) \times U(1)$  coming from  $CP2 = SU(3) / SU(2) \times U(1)$

**To each D4 add B4 Vectors and F4 Spinors**



**D4 - Spin(8)**  
**Cl(8) BiVector skeleton**



**B4 - add OP1**  
**Cl(8) Vector muscle**



**F4 - add OP2**  
**Cl(8) Spinor skin**

**Each D4 grows into B4 (  $B4 / D4 = OP1$  )**

**Each B4 grows into F4 (  $F4 / B4 = OP2$  )**

**Each F4 grows into H4 ( F4 root vectors = 24-cell + dual 24-cell  
with dual 24-cell 24 vertices replaced by 96 Golden Ratio points  
consistently placed on 96 edges of dual 24-cell)**



There are two ways to place the Golden Ratio Points,  
one way for each of the two H4 emerging from the two D4.

**For the two H4 the 96 Golden Ratio points represent:**

64 of A7+R Unimodular Group of 8-dim Spacetime ( 32 for M4 and 32 for CP2 )

64 = 8 components of 8 Fermion Particles ( 32 for M4 and 32 for CP2 )

64 = 8 components of 8 Fermion AntiParticles ( 32 for M4 and 32 for CP2 )

Finally, 120 + 120 root vectors of the two H4 = 240 root vectors of E8.

**Cl(16) BiVectors + half-Spinors = E8**



**120 H<sub>4</sub> + 120 H<sub>4</sub> = 240 Root Vectors of E<sub>8</sub>**

240 E8 Root Vectors that live in the 8-dim E8 Root Vector Space have been represented by Ray Aschheim in 2-dim:

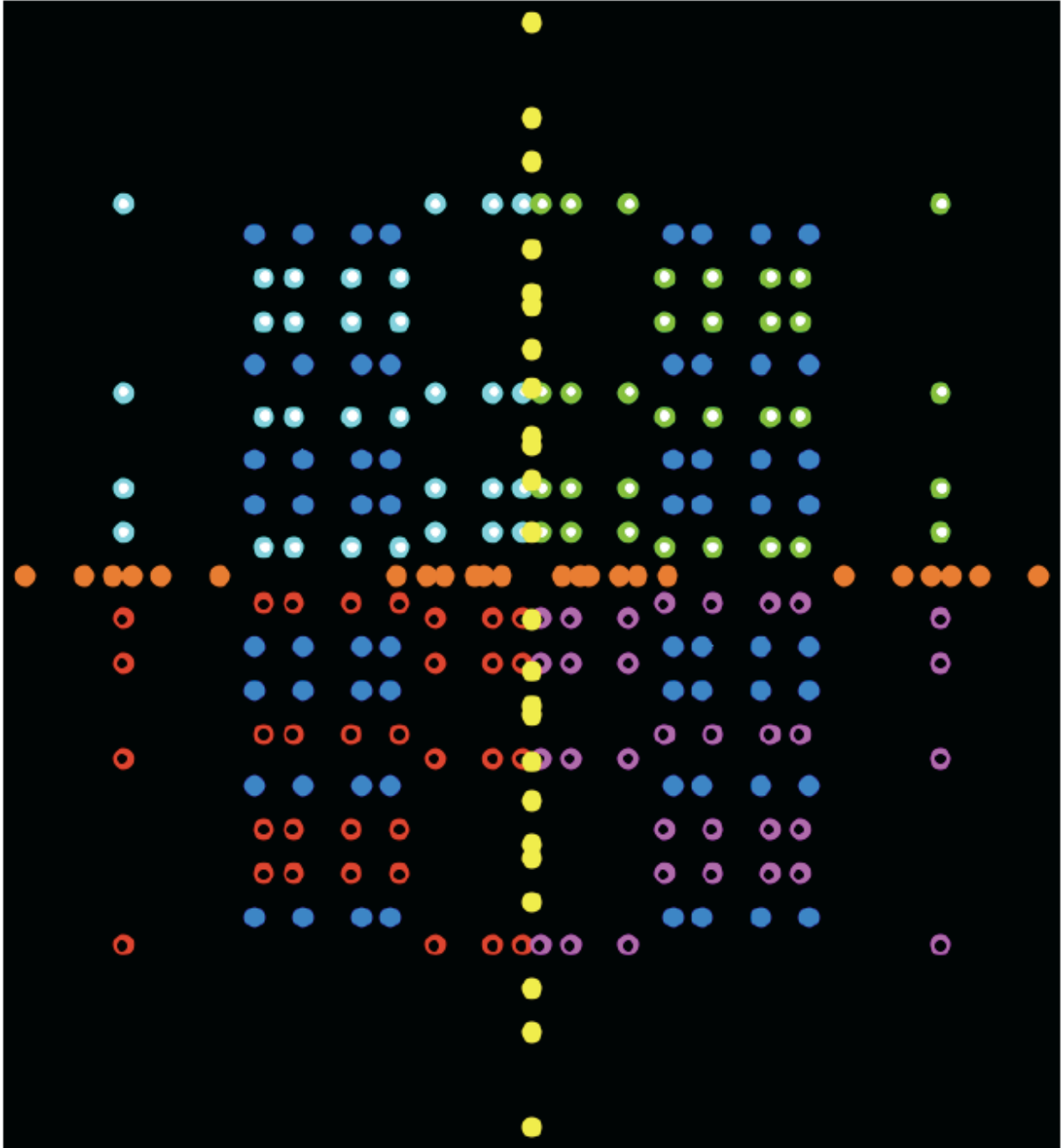

248-dim E8 = 120-dim Spin(16) D8 + 128-dim half-spinor of Spin(16) D8  
 240 E8 Root Vectors = 112 D8 Root Vectors + 128 D8 half-spinors  
 112 D8 Root Vectors = 24 D4 (orange) + 24 D4 (yellow) + 64 (blue)  
 128 D8 half-spinors = 128 elements of E8 / D8  
 Green and Cyan dots with white centers (32+32 = 64 dots) and  
 Red and Magenta dots with black centers (32+32 = 64 dots)  
 correspond to the 128 elements of E8 / D8.

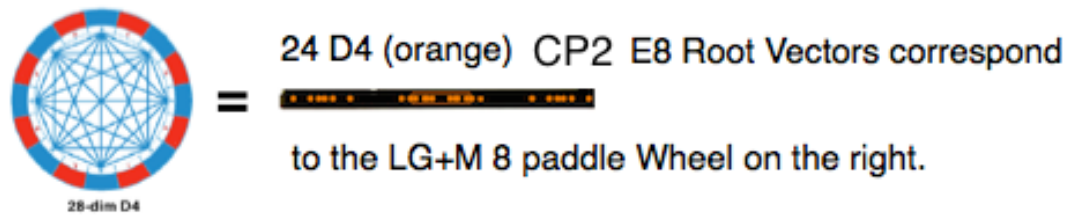
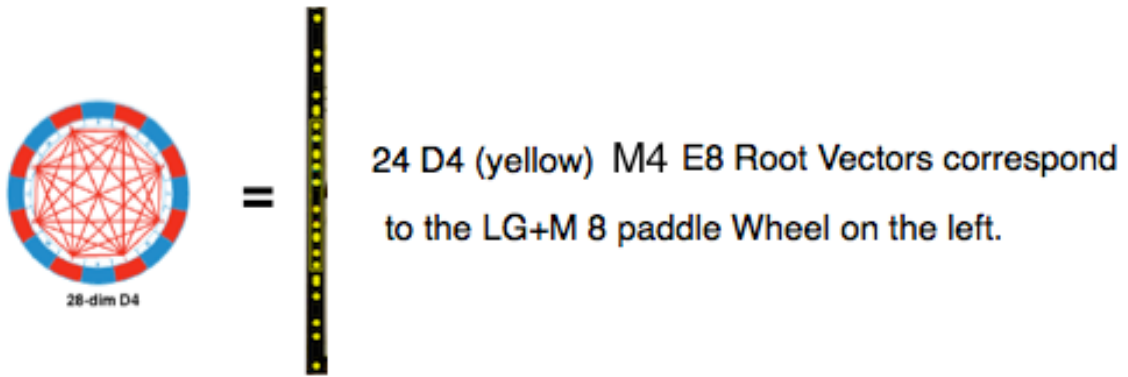

The other  $64 + 64 + 64 = 192$  E8 Root Vectors correspond to the 6 Windows as:

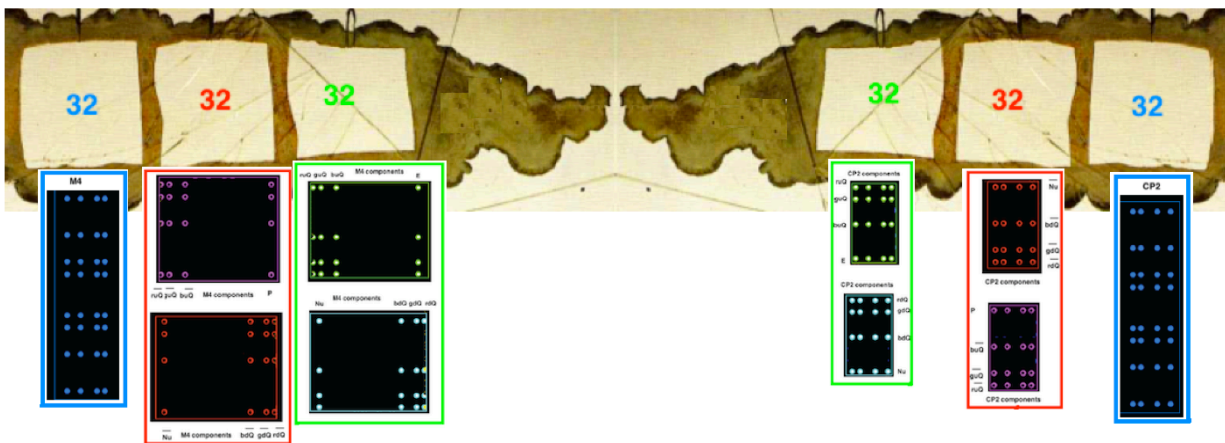

$$\text{Cl}(16) \text{ Vectors} = \text{Lie Ball Spin}(10) / \text{Spin}(8) \times \text{U}(1)$$

**Cl(16) has 16 Vectors** represented by Duchamp as small black dots

( Duchamp placed two other small black dots in the H4 regions



perhaps to indicate duality of the two D4-B4-F4-H4 structures and complexification of F4 and J3(O) to E6 and Fr3(O) )

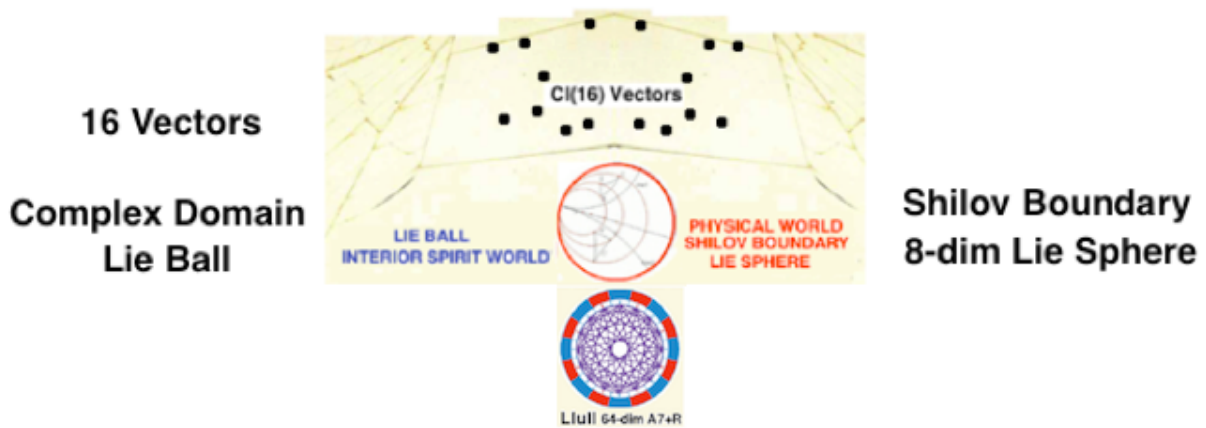

Cl(16) Vectors = Lie Ball Spin(10) / Spin(8)xU(1) Symmetric Space  
 with Bounded Complex Domain of Hua Type IV(8)  
 whose Lie Sphere Shilov Boundary  
 is 8-dim Spacetime with Unimodular Symmetry A7+R  
 that is Base Manifold for a Lagrangian based on E8 structure

$$\begin{array}{c}
 \text{64-dim A7+R} \\
 \text{Llull}
 \end{array}
 = \begin{array}{|c|} \hline \text{E8} \\ \hline \end{array} + \begin{array}{|c|} \hline \text{E8} \\ \hline \end{array} = \begin{array}{c}
 32 \text{ M4 Components} \\
 \text{of 8 Spacetime Superposition E8 Lattices} \\
 + \\
 32 \text{ CP2 Components} \\
 \text{of 8 Spacetime Superposition E8 Lattices}
 \end{array}$$

The 64 Blue Root Vectors of the space  $D_8 / D_4 \times D_4$  represent 8D Spacetime and the  $A_7 = SL(8,R)$  of Unimodular Gravity that is in the Maximal Contraction Heisenberg Algebra of  $E_8$  with structure  $28 + 64 + (A_7+R) + 64 + 28$  of Quantum Creation / Annihilation Operators of Particles and Spacetime

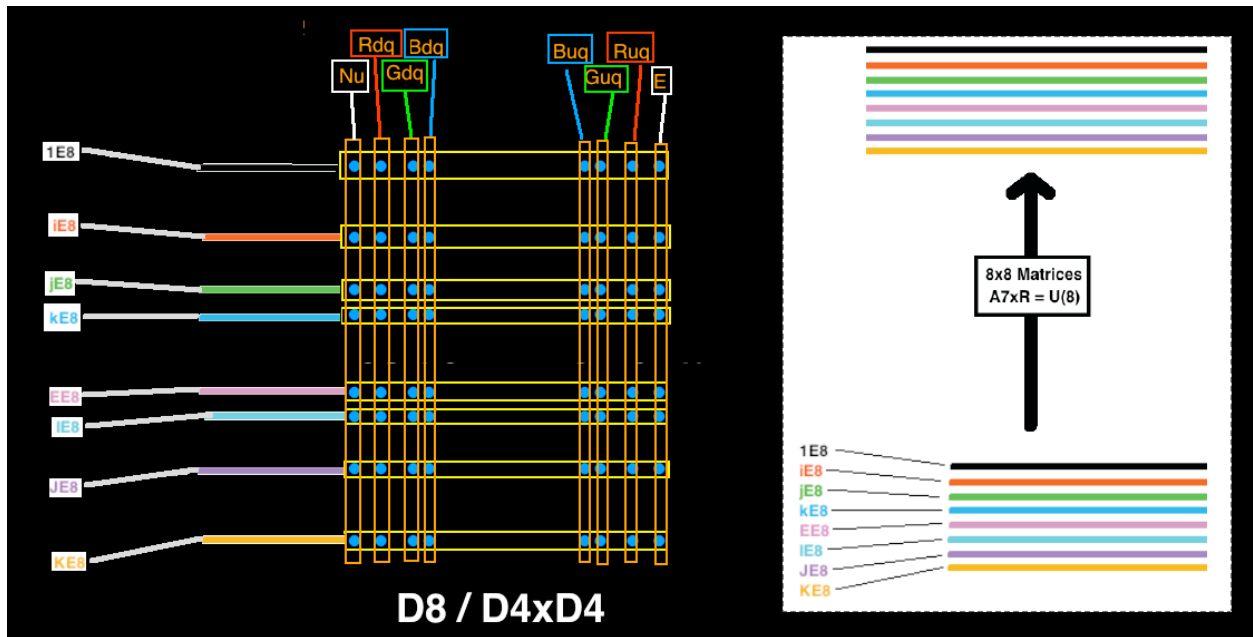
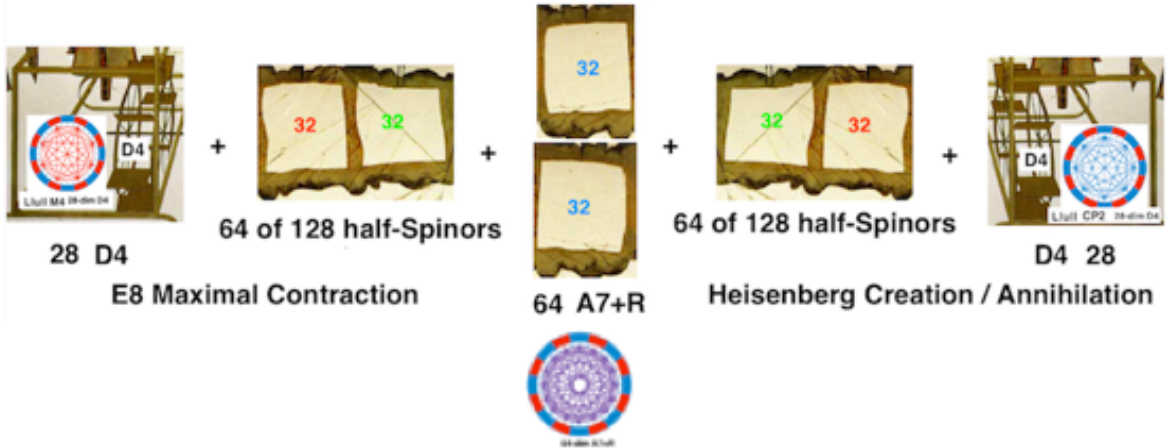



# Cl(16) Vectors and BiVectors + half-Spinors

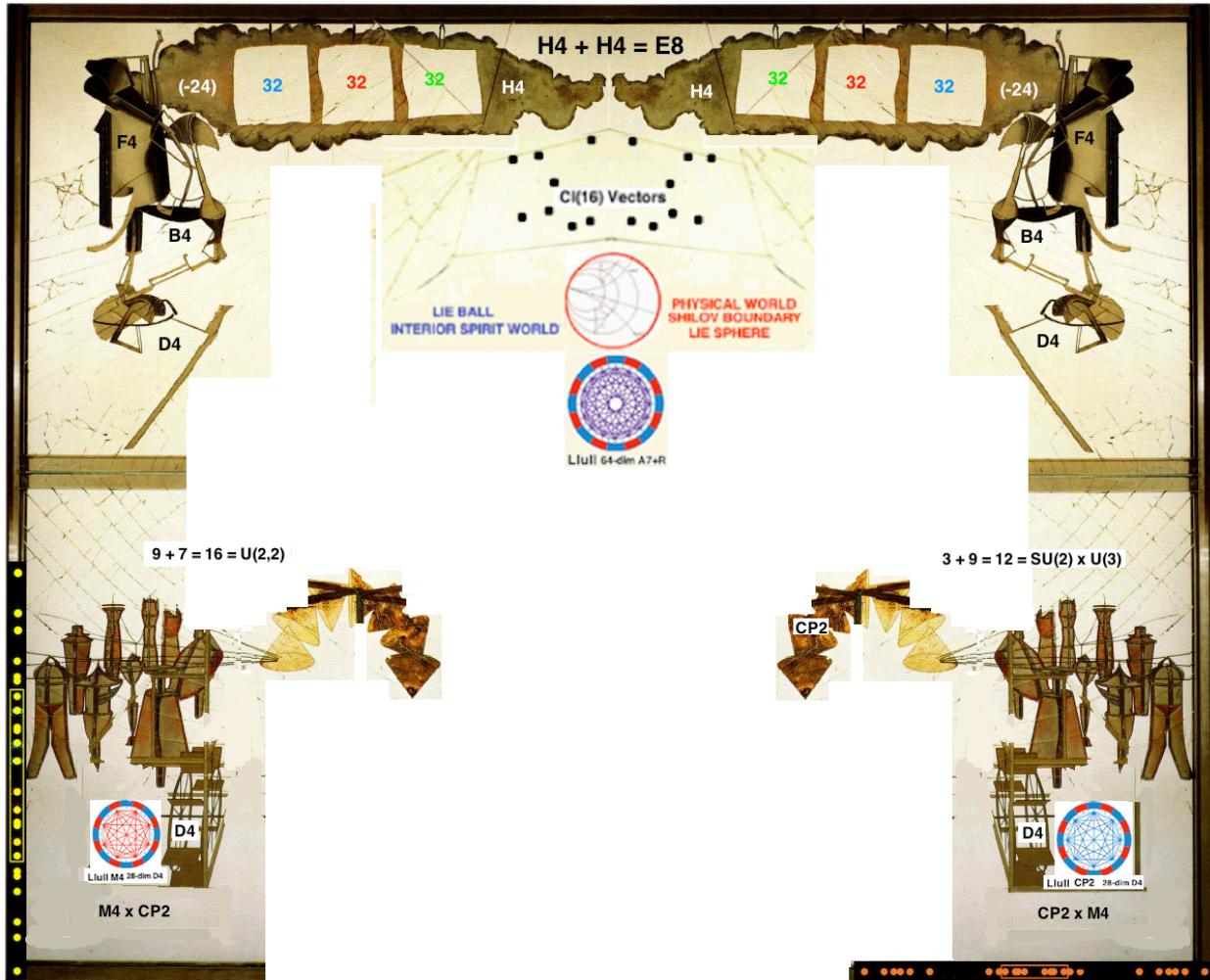

## 560 Cl(16) TriVectors = 10 copies of 56-dim Fr3(O)

Only one copy of Fr3(O) is explicitly shown by Duchamp because the 10 copies are one for each of  $26-16 = 10$  dimensions of 26D String=World-Line Theory with all 10 being in a State of Superposition

8 of the 10 dimensions are represented by 8 algebraically independent E8 Lattices (7 Integral Domains) so that each of the 8 types of Fermions has its own E8 Lattice

**26D String=World-Line Theory comes from Fr3(O) =**  
 = 56-dim Freudenthal Algebra Fr3(O) = Complexification of 27-dim J3(O)  
 with 26-dim traceless part J3(O)

The Large Glass + Mirror connects World-Line Strings with the volumes of M4 and CP2 parts of Spacetime and  
 56 of the 560 TriVectors of Cl(16) = Fr3(O) =  $1+8+8+8+1+1+1 + 1+8+8+8+1+1+1$

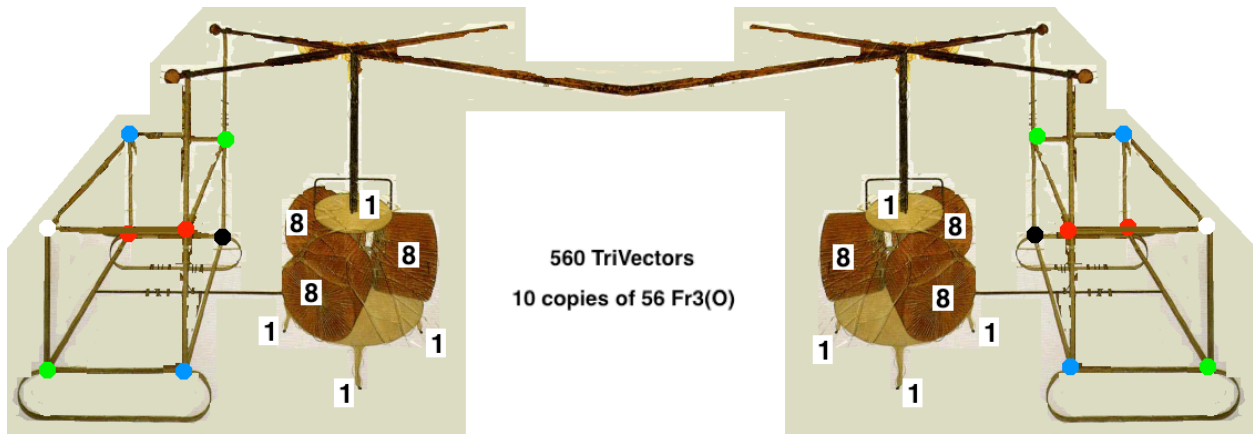

Strings = World-Lines in M4 and CP2 interact by entire fine-grained histories in Andrew Gray's quant-ph/9712037v2 Quantum Theory with interference factors among different possible histories at each time. Each Gray History is a World-Line String.



**The Gray Fine-Grained History Quantum Theory is equivalent to the Nambu-Goto action of 26D String Theory.**

**Nambu-Goto symmetric 24x24 traceless spin-2 particle is Quantum Bohmion carrier of Bohm Quantum Potential**

Nambu-Goto antisymmetric SO(24) little group is related to the Monster automorphism group that is the symmetry of each cell of Planck-scale local lattice structure.

Tachyons localized at orbifolds of fermions produce virtual clouds of particles / antiparticles that dress fermions as Schwinger Sources.

www.outline-of-knowledge.info/OKD/5/Physics/Matter/Atom/Orbital/Spin/spin%20of%20particle.html said "... Spin-2 particles are tensors, with two symmetry axes ...".

Richard Feynman in his Lectures on Gravitation said "... The polarization of a graviton is a tensor quantity. ... we draw arrows indicating the direction to be associated with surfaces normal to the axes. In the plane perpendicular to the direction of propagation we have the two stresses ... These are the only two possible quadrupole stresses; the stresses representable by all arrows pointing towards the origin (or away from the origin) are something like a fluid pressure, which has zero spin.

The "stresses" (actually rotations) representable by all arrows pointing in a clockwise (or counter-clockwise) direction correspond to spin 1. ...

The stresses represented by ...

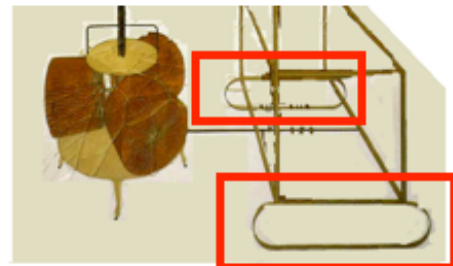
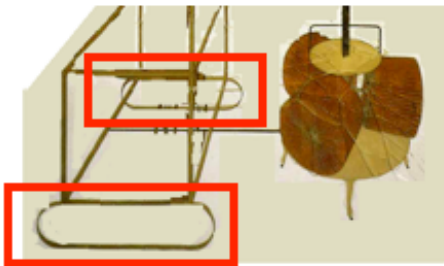
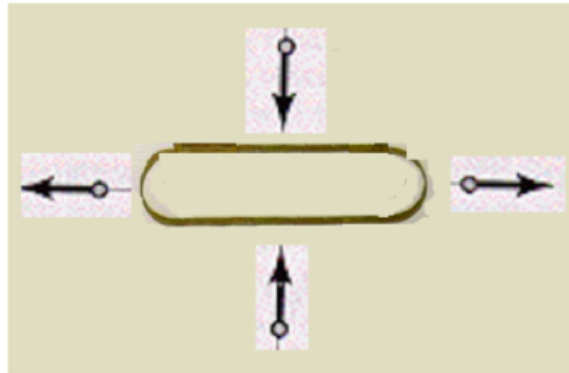

... have ... spin ... two ... a complete 360 degree rotation corresponds to two complete cycles of phase ...".

The 4 such "runners" of the TriVector part of the Large Glass + Mirror (in red boxes) correspond to a Spin-2 Bohm Quantum Potential Bohmion

One of the two M4 "runners" carries 2 of the 4 M4 components of the Bohmion. The other M4 "runner" carries the other 2 of the 4 M4 components of the Bohmion.

One of the two CP2 "runners" carries 2 of the 4 CP2 components of the Bohmion. The other CP2 "runner" carries the other 2 of the 4 CP2 components of the Bohmion.

# CI(16) Vectors and BiVectors + half-Spinors and TriVectors

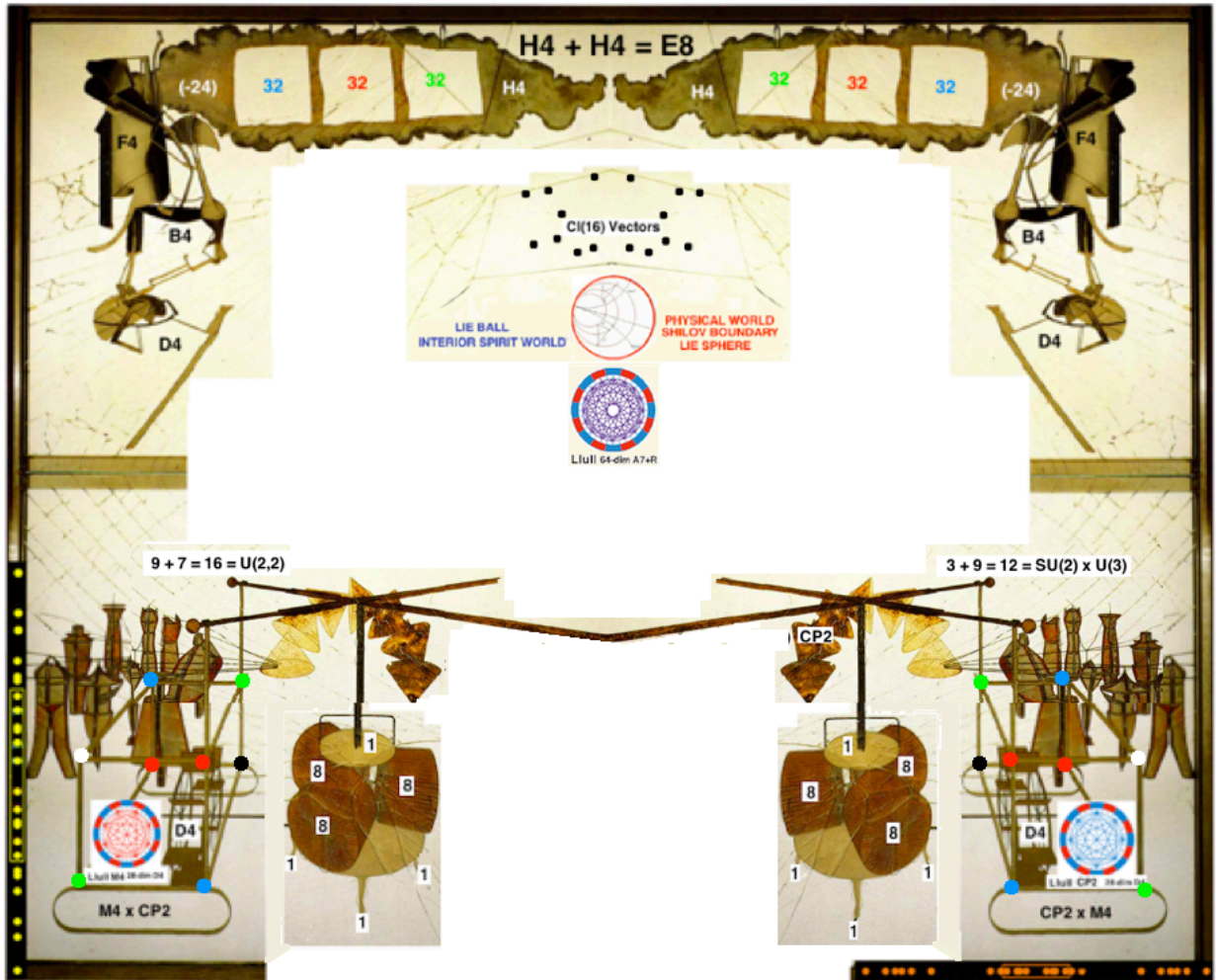

## Conscious Smiling Spirit Being

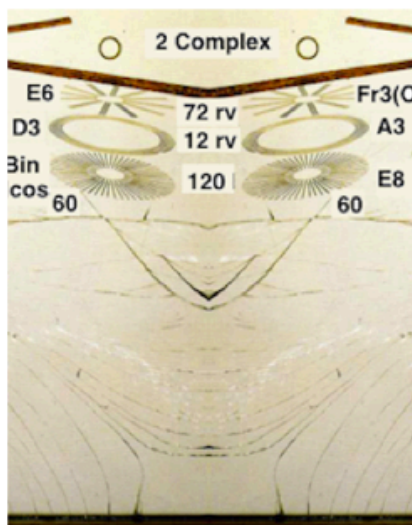

To me the Lower Central part of the Large Glass + Mirror looks like a Smiling Spirit Being with 4 pairs of circular eyes. The eyes (and eyebrow type Strings=World-Lines) are the work of Marcel Duchamp but the rest of the Smiling Spirit Being image is formed by cracks in the Glass from it being accidentally dropped by movers in Brooklyn in 1927. Therefore you might say that the Smiling Spirit Being is a product of the Spirit World, with Spirits influencing accidents.

### What did Duchamp think of the Spirit World ?

John F. Moffitt in "Alchemist of the Avant-Garde the case of Marcel Duchamp" said:  
"... ... the real issue is the correct identification of "Duchamp's historical, contemporary sources or influences." ... two widely read "master-key" and "scientific" classics of fin de siècle Occultism ...[ were by ]... Helena Blavatsky ... and Papus ... between 1915 and 1923 ... the esoteric activities mutually pursued by Duchamp, Arensberg, and Dreier is what is now known as "New York Dada." ... One of Dreier's favorite Theosophical authors was Rudolf Steiner (1861–1925)...

[ Rudolf Steiner studied the **Spirit World and how it relates to the Physical World** ( Geisteswissenschaft ) in building his Goetheneanum. see viXra 1810.0365 ]  
Steiner proclaimed ... **an Art will arise ... filled with spirit ... transcend[ing] nature.**  
Once Nature has been transcended, then, says Steiner

**"... large numbers of people will feel spiritual life to be a vital necessity, when spiritual life and practical life are finally brought into direct connection with each other. ..."**

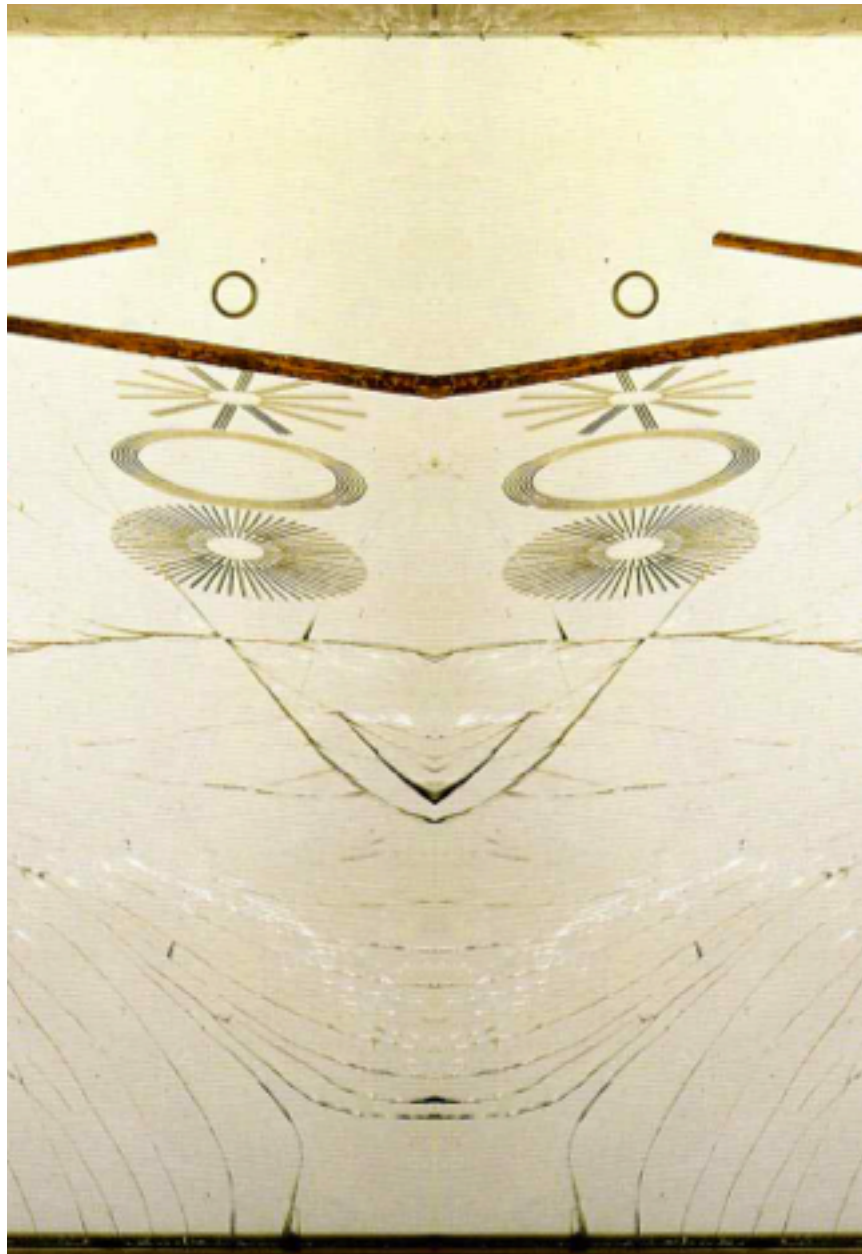

If the 4 pairs of eyes represent 4 thoughts in the Mind of the Smiling Spirit Being, they would be

Cl(16) Vectors:  
 $1+1 = 2$ -dim Complex Numbers  
 for Lie Ball Bounded Complex Domain  
 of Symmetric Space  $\text{Spin}(10) / \text{Spin}(8) \times U(1)$

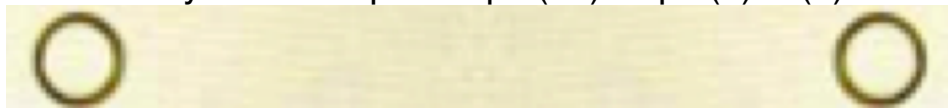

Cl(16) TriVectors:

$36+36 = 72$  Root Vectors of E6 automorphism group of 56-dim Fr3(O)  
that is Complexification of 27-dim J3(O)  
whose traceless part is 26-dim J3(O)o



Cl(16) BiVectors:

$6+6 = 12$  Root Vectors of D3 = A3  
D3 contains Conformal Spin(2,4) for Gravity + Dark Energy acting on M4  
A3 = SU(4) contains SU3 acting on CP2 = SU(3) / SU(2)xU(1)

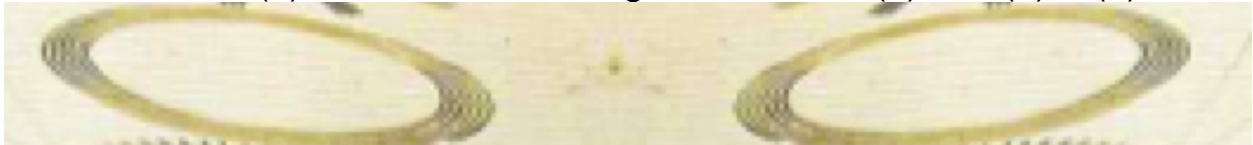

Cl(16) BiVectors and half-Spinors:  
 $60+60 = 120$  Binary Icosahedral Group  
in McKay Correspondence with E8

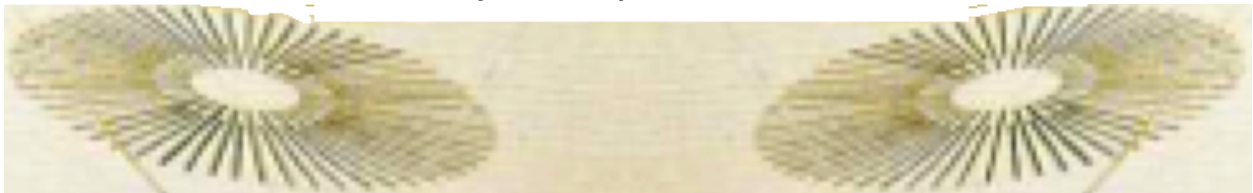

Jennie Louise Cain in her 2016 U. Michigan Ph.D. thesis says:

“... Rudolf Steiner (1861-1925) ... was the founder of Anthroposophy, a philosophy and spiritual movement whose aim ... is to develop supersensible capacities that enable access to what Steiner described as a spiritual dimension underlying all of life ... Steiner argues that the loss of original clairvoyant capacities ... of ... the ancient ... culture ... was necessary for the development of intellectualism ... “Geisteswissenschaft” ... is the re-awakening of a spiritual awareness ... Steiner ... regards ...the ancient Egyptians ... as oriented toward connection and interaction with the outer world, and ... the greater astronomical cosmos

...

the age of the Egyptian pyramids [was] the time of development of the “Empfindungsseele” ... the ability to experience the outer world internally ...

**The pyramid itself is ... a large, sensing organ (an “Empfindungsorgan”)  
that picks up the relationship of the earth culture as a whole to the cosmos ...”.**

**Physics of the Cosmos is based on 65,536-dim Cl(16) Clifford Algebra**

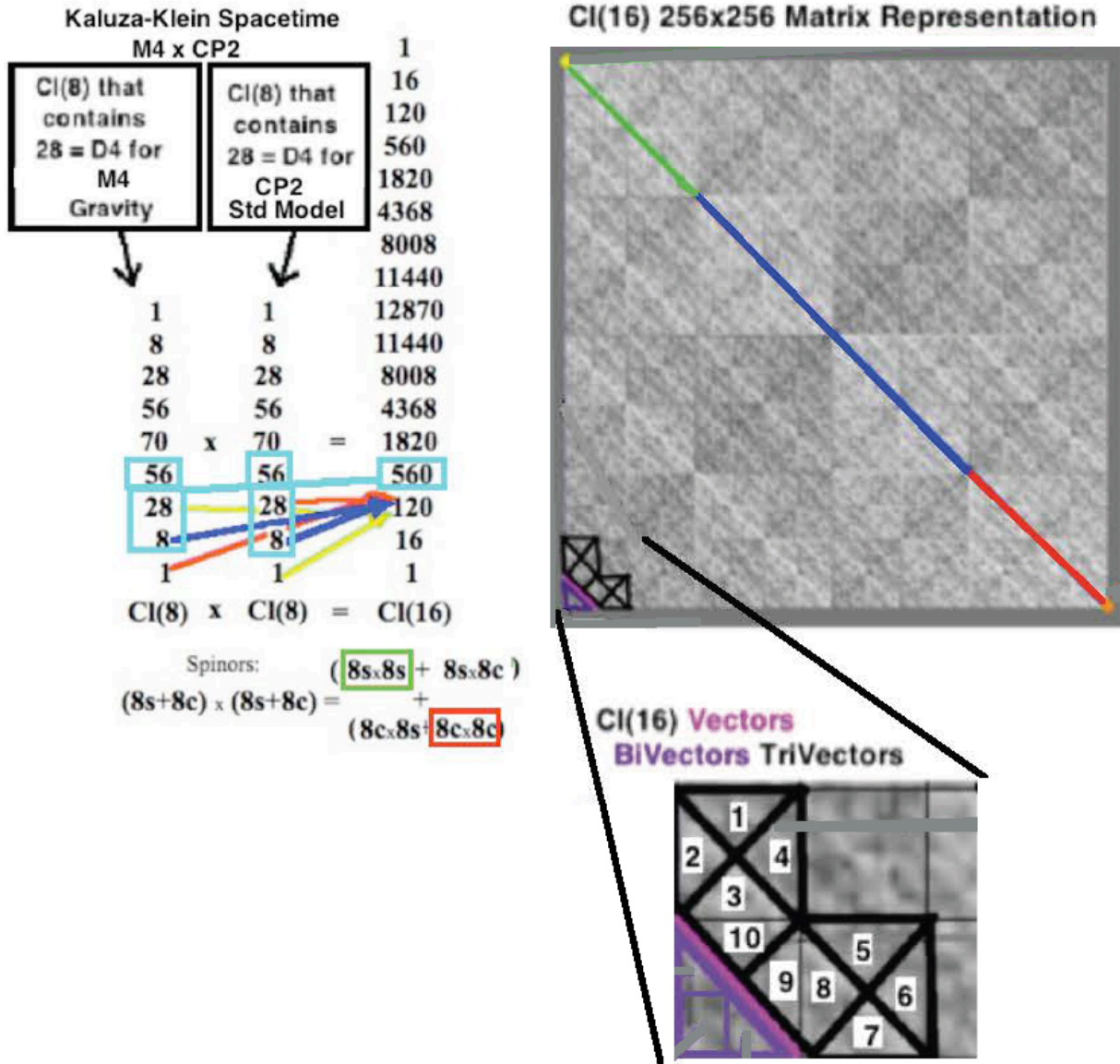

**Earth culture is based on Human Quantum Consciousness of Microtubules = 40 micron size aggregates of 65,536 Tubulin Dimers.**

Assembly of 65,536 tubulins into a 40-micron microtubule can be seen to be analogous to the Real Clifford Algebra  $Cl(16) = 256 \times 256$  tensor product  $Cl(8) \times Cl(8)$  where one 256-dim  $Cl(8)$  represents Conformal Gravity+Dark Energy with  $F_{4gde}$  related to the Minkowski  $M_4$  of Kaluza-Klein  $M_4 \times CP_2$  and the other  $Cl(8)$  represents Standard Model  $U(1) SU(2) SU(3)$  with  $F_{4sm}$  related to the  $CP_2 = SU(3) / SU(2) \times U(1)$  of Kaluza-Klein  $M_4 \times CP_2$ .



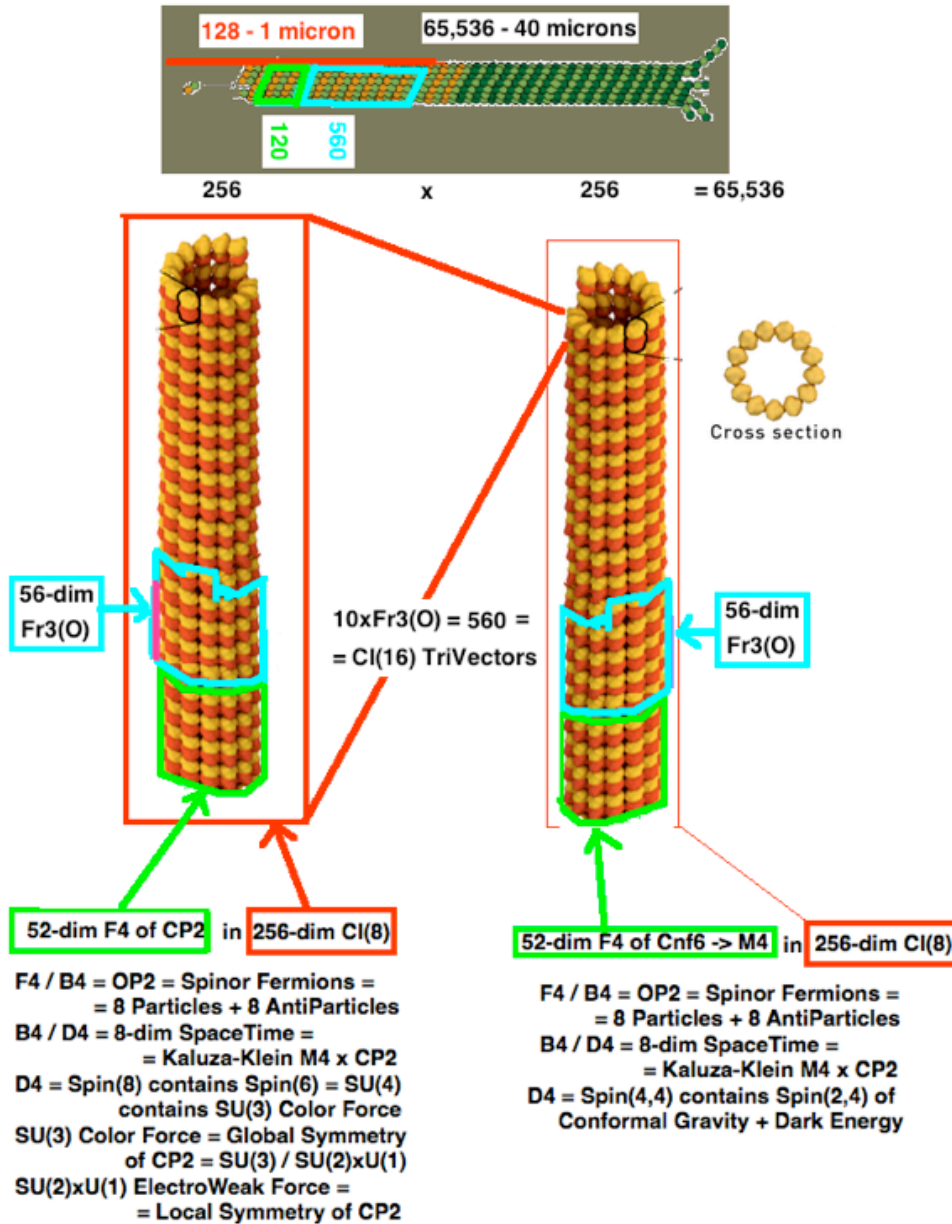

**The Earth Culture sees its relationship to the Cosmos as being reflected in the structures of the Giza Pyramids and Sphinx.**

After the victories of Alexander the Great, his friend, historian, and general Ptolemy Iruled Egypt and its cultural center Alexandria and commissioned Manetho to document history which history included:

**36,525 years ago - North Star Vega - Humans migrated up the Nile River to Giza where they built two large Pyramids - each representing Cl(8) whose 8 Vectors + 28 BiVectors + 16 Spinors = F4 Lie Algebra one for F4gde = Conformal Gravity + Dark Energy**

one for F4sm = Standard Model  
 and  
 the Sphinx - representing  $Cl(16) = Cl(8) \times Cl(8)$   
 whose 120 BiVectors + 128 half-Spinors = E8 = Lagrangian  
 and  
 whose 560 TriVectors = 10 copies of  $Fr3(O) = 26D$  World-Line-String Theory

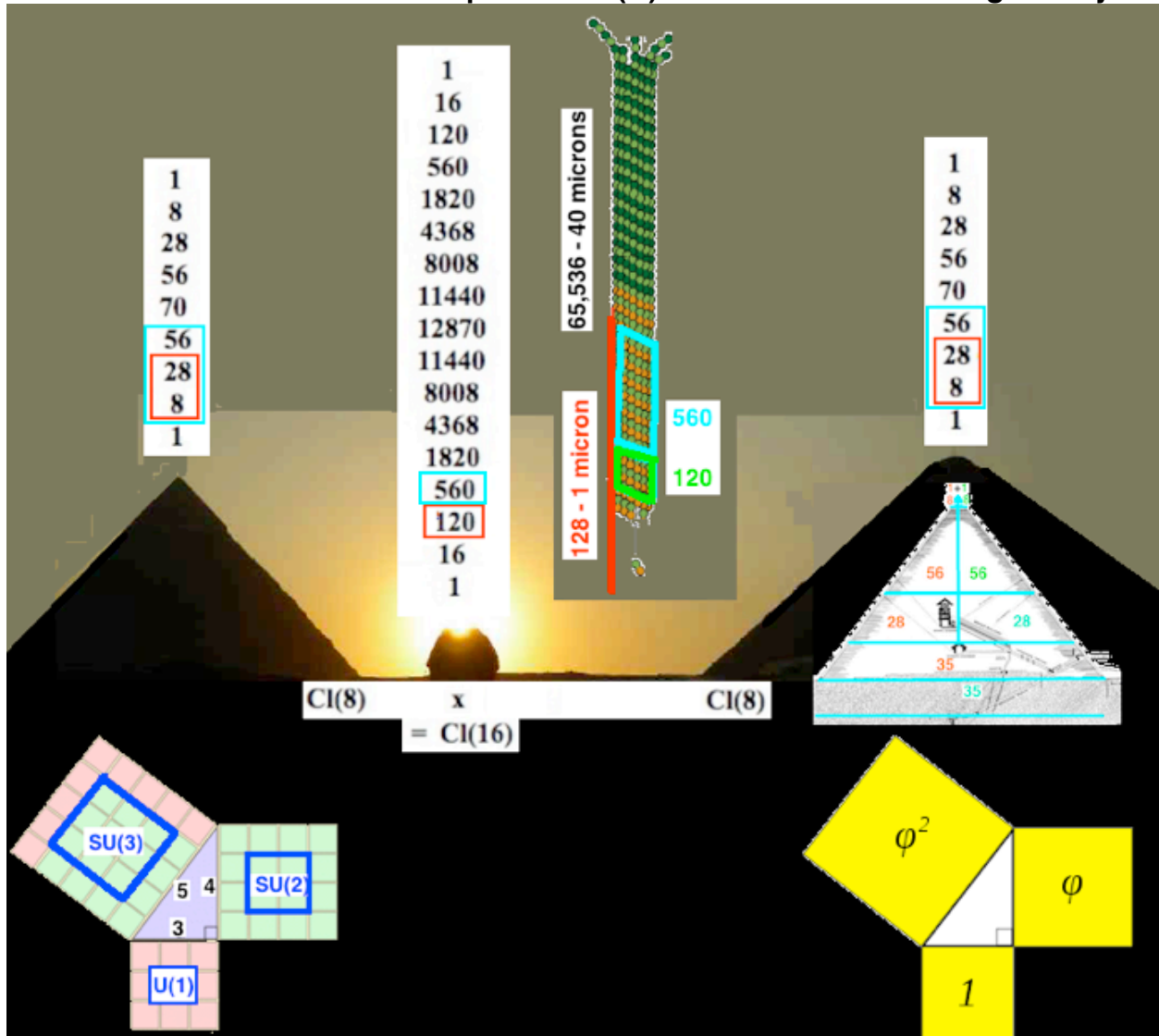

Rudolf Steiner, in Cosmic Memory, said "... The Fourfold Man ... consists of ... the physical body, the ether ... body, the astral body and the " I " ...".

Physical Body is constructed of 40-micron Microtubules = 65,536 Tubulins  
 Ether Body is Information coded in the 64,712 Information Tubulins of the Microtubule  
 Astral Body is 26D World-Line Theory Lattice Cell with 65,536-dim  $Cl(16)$  Symmetry  
 " I " is Information encoded in the 64,712 Information elements per Lattice Cell

$D_1 = 560 = 10 \times Fr3(0)$   

1	120	560	1820	4736	8008	11440	12870	11440	8008	4736	1820	560	120	1
---	-----	-----	------	------	------	-------	-------	-------	------	------	------	-----	-----	---

  
 $+(1/2) \sqrt{55,536} = 128$      $128 \times 128 = 240 \text{ E9}$

**Planck Scale C(16) of 16D Complex Domain**  
**LIE BALL**  
**INTERIOR SPIRIT WORLD**

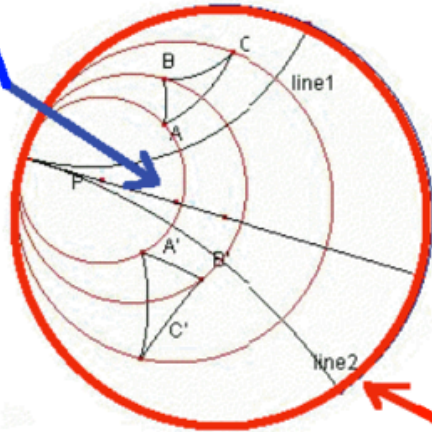

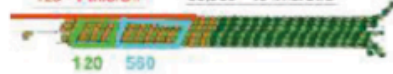

  
 $10^{(-24)}$  cm Scale Elementary Particle  
 Schwinger Sources

**Nanometer - Micron Scale**  
**Tubulin Dimers and Microtubules**  
 $128 - 1 \text{ micron}$      $65,536 - 40 \text{ microns}$   

  
 $120$      $560$

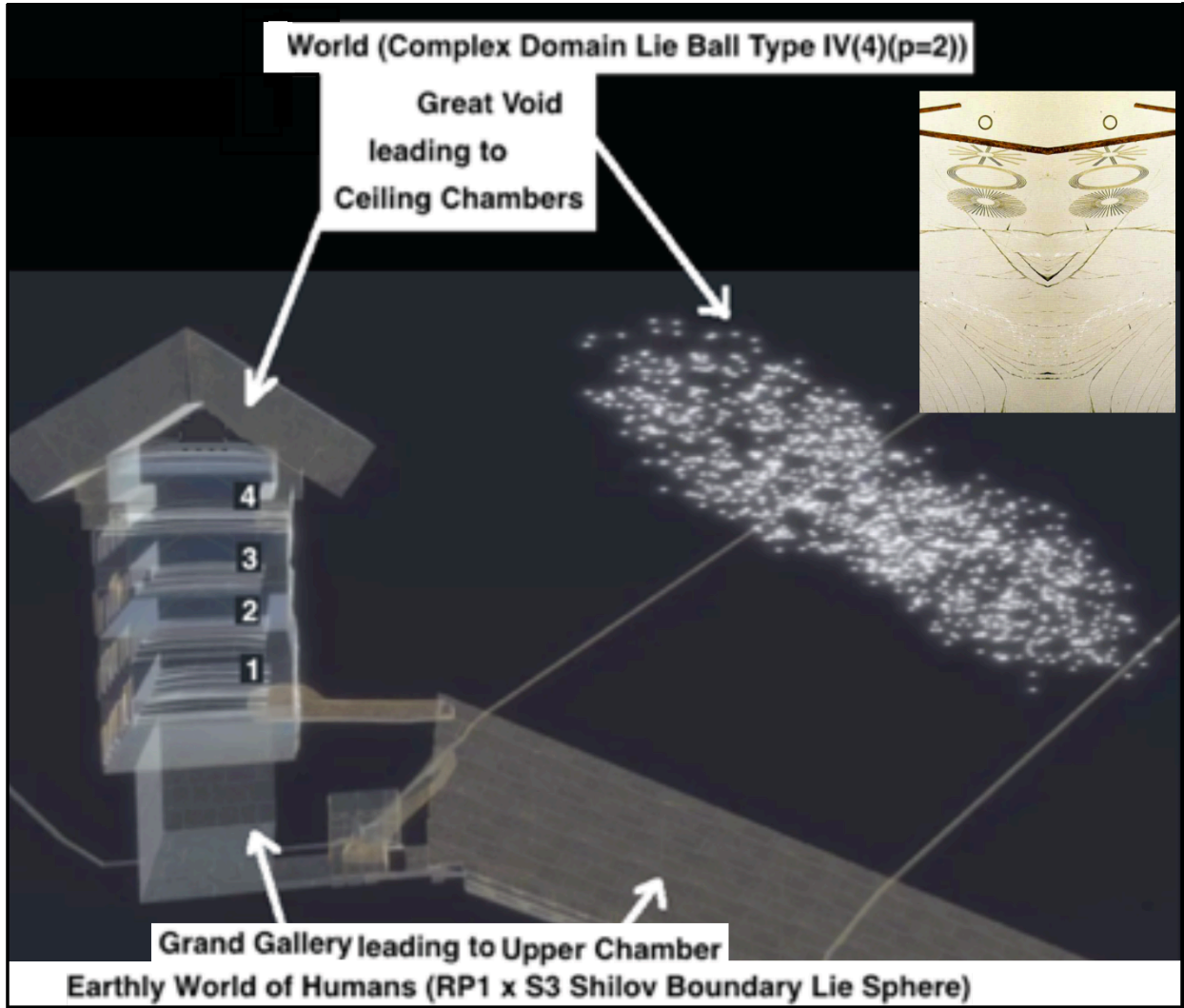
**Planck Scale E8 of 8D Real**  
**Shilov Boundary Physical Spacetime**  
**PHYSICAL WORLD**  
**SHILOV BOUNDARY**  
**LIE SPHERE**

The Builders of the Great Pyramid represented the Real Shilov Boundary Physical world by the Grand Gallery and Upper Chamber that are easily accessible by Humans with Microtubule Quantum Consciousness and they represented the Imaginary Complex World of C(16) Spacetime Cells mirroring the Human Microtubule World as Ceiling Chamber spaces and the Great Void that are more accessible to Souls of the Spirit World than to Physical Humans.



The Spirit Being  is made up of glass-break lines from Brooklyn movers accidentally dropping the Large Glass, and so a Spiritual Being of Spiritual Art, and so also belongs to the Spiritual Realm of Music.

# CI(16) Vectors and BiVectors + half-Spinors and TriVectors and Conscious Smiling Spirit Being

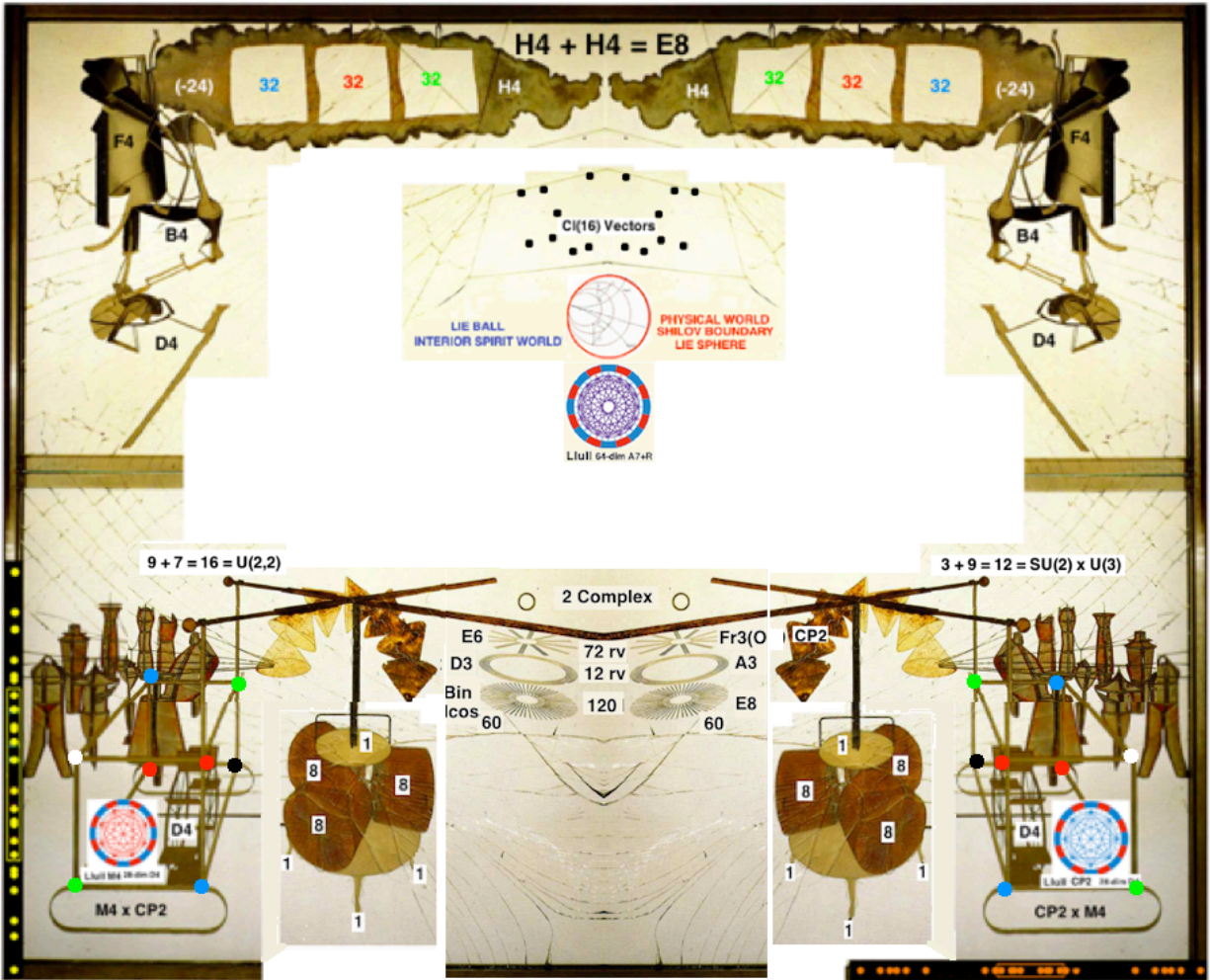

# Overview of LG+M and CI(16)

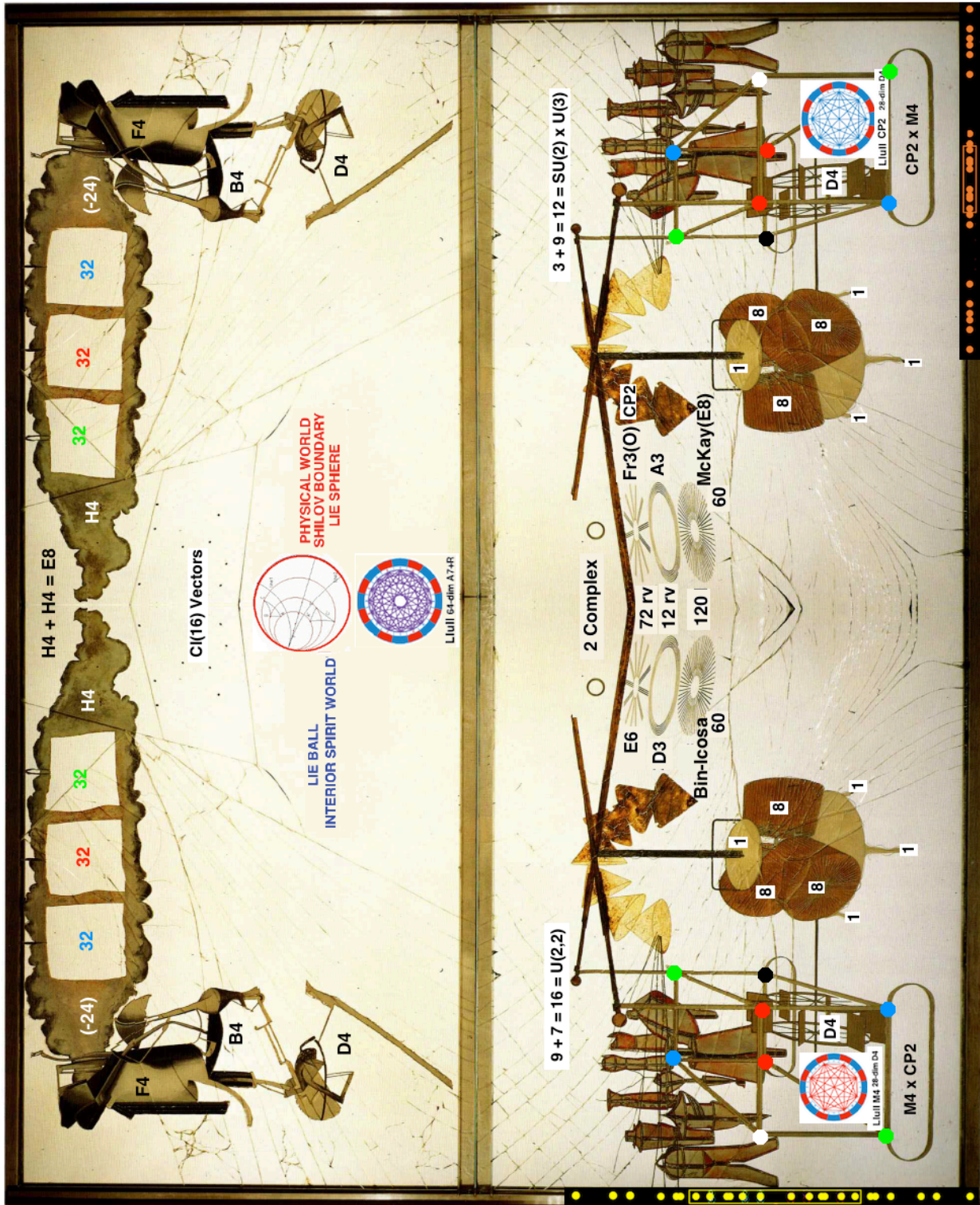

## CI(16) Lagrangian

Here is the CI(16) Lagrangian written in terms of E8 Root Vectors and CI(16) structure:



The **Base Manifold** is the 8-dim **Shilov Boundary** of the 16-dim **CI(16) Vectors**

The **Vector space** is the **Lie Ball Spin(10) / Spin(8) x U(1)**  
and the **Shilov Boundary** is the **Lie Sphere RP1 x S7** with Octonionic structure

The **Lagrangian Density** terms are based on the structure of E8 =  
= **CI(16) BiVectors + half-Spinors**

**E8 / D8** = 128-dim half-spinors of CI(16) = Fermion Particles and AntiParticles

**D8 / D4xD4** = A7+R creation / annihilation operators for 8-dim Spacetime

**D4** = 28 Spin(8) generators acting as 8-dim gauge bosons

**D4** = 28 Spin(8) generators acting as 8-dim gauge bosons

The following page is a larger image of the Lagrangian

which page is followed by more details about the Base Manifold and the Density.

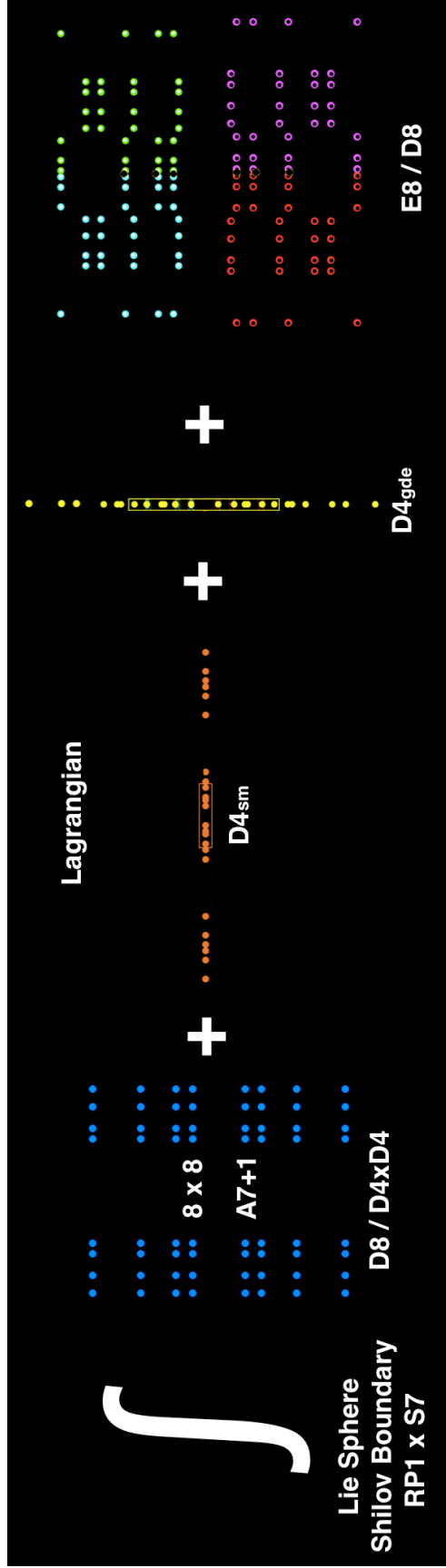



## Base Manifold

The **Base Manifold** is the 8-dim Shilov Boundary of the 16-dim Vector space of  $Cl(16)$ .

The **Vector space is the Lie Ball  $Spin(10) / Spin(8) \times U(1)$**   
 and the **Shilov Boundary is the Lie Sphere  $RP^1 \times S^7$**  with Octonionic structure  
 1-dim Real Part  $Re(O)$  + 7-dim Imaginary Part  $Im(O)$  so

Since  $Im(O)$  contains a 3-dim associative submanifold  
 plus an orthogonal 4-dim coassociative submanifold  
 the 8-dim base manifold is made up of two 4-dim parts:

Associative =  $Re(O)$  + Associative Submanifold of  $Im(O)$   
 Coassociative = Coassociative Submanifold of  $Im(O)$

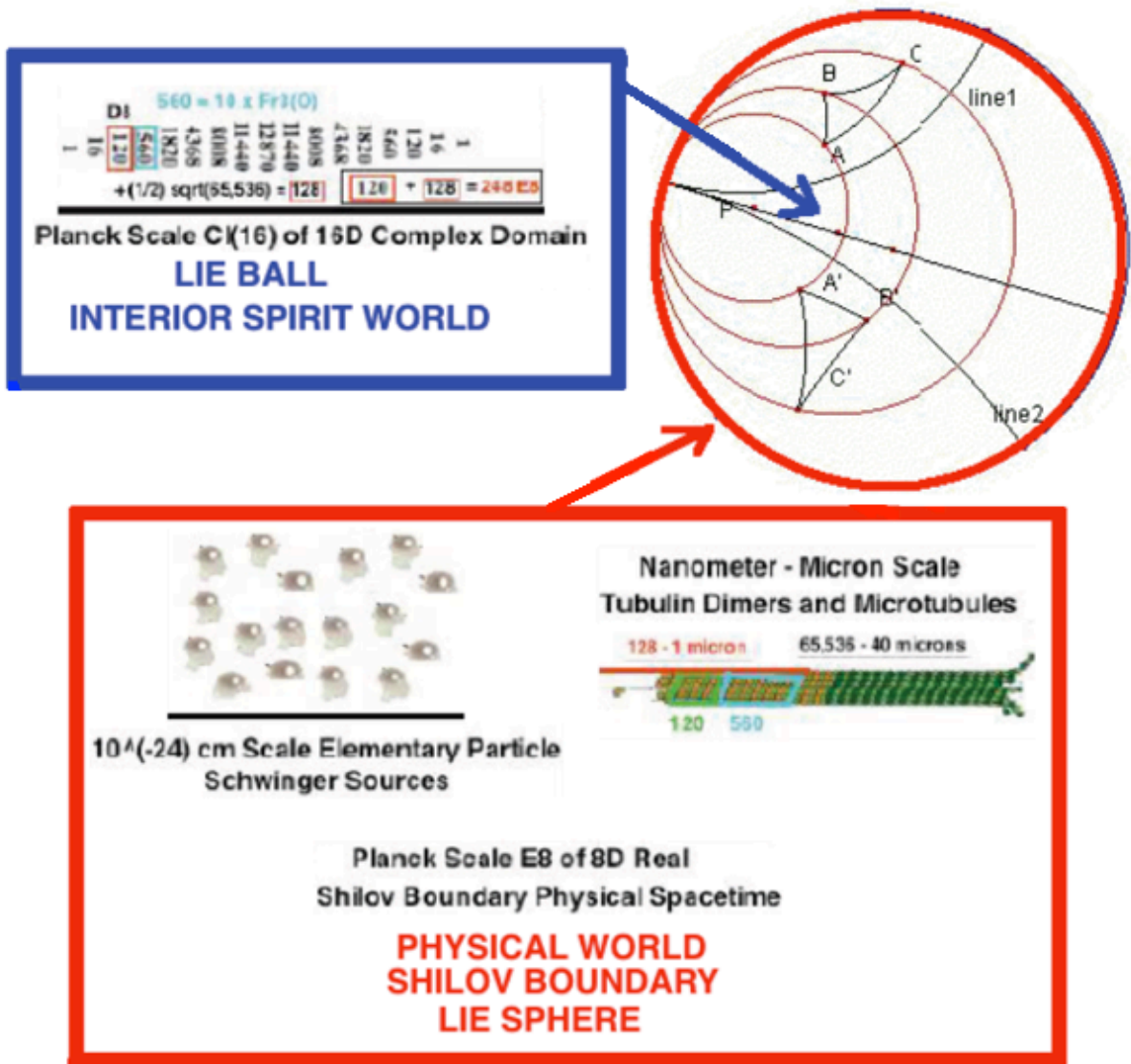

## Lagrangian Density



The 10 dimensions of the Vector Space of Spin(10) account for 10 of the 26 dimensions of 26D String=World-Line Theory. 8 of those 10 dimensions, the Shilov Boundary, are Octonionic 8-dim Spacetime that becomes Quaternionic  $M4 \times CP2$  Kaluza-Klein at low (relative to Planck) energies.

The  $26-10 = 16$  dimensions correspond to orbifold representations of 8 First-Generation Fermion Types: 8 Particles + 8 Antiparticles each with 8 components.

They give the **Lagrangian Density terms labelled E8 / D8**

Weinberg showed in Dirac lecture: each fermion has weight  $7/2$  in the 8-dim Lagrangian

The **Lagrangian Density terms labelled D4gde** are the 24 Root Vectors of one of the two 28-dim D4 acting as 8-dim gauge bosons.

Weinberg showed in Dirac lecture: each gauge boson has weight 1 in the Lagrangian

The **Lagrangian Density terms labelled D4sm** are the 24 Root Vectors of the other of the two 28-dim D4 acting as 8-dim gauge bosons.

Weinberg showed in Dirac lecture each gauge boson has weight 1 in the Lagrangian

Since  **$(8+8)$  fermions  $\times 7/2 = 56 = 28$  gauge bosons  $\times 1 + 28$  gauge bosons  $\times 1$**  there is a subtle fermion-gauge boson supersymmetry leading to ultraviolet finiteness.

The **Lagrangian Density terms labelled D8 / D4xD4** are  $8 \times 8 = 64$  dimensions =  $= 8$  Fermion Types  $\times$  (  $8$  Octonion Basis Elements =  $8$  E8 Lattices )  
 There are 8 algebraically independent E8 Lattices, 7 of which are Integral Domains corresponding to the 7 Imaginary Octonions and to the 7 massive Fermion Types and 1 of which corresponds to the Real Octonion Axis and to Neutrino-Type Fermions which are tree-level-massless.  
 The physical 8-dim Octonionic Spacetime is a Superposition of those 8 E8 Lattices in which each Fermion Type propagates in its own E8 Lattice.

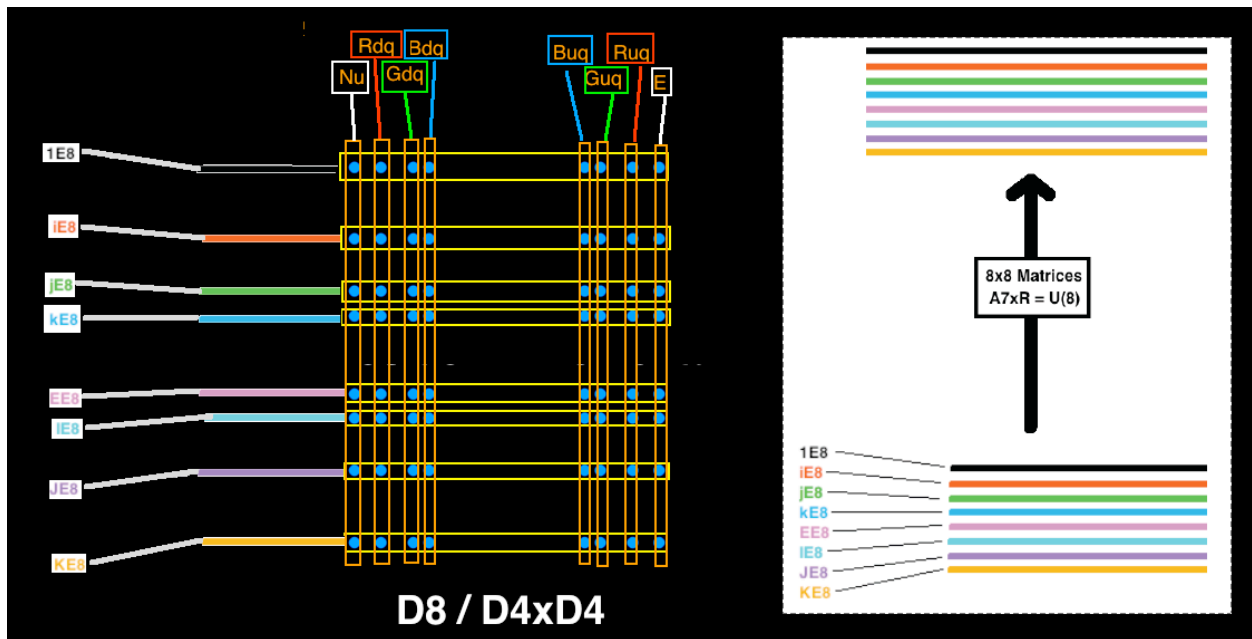

The  $8 \times 8 = 64$ -element **D8 / D4xD4** structure is  $A7+R = SL(R,8) + 1$  which is the grade-0 part of the Heisenberg Algebra = Maximal Contraction of E8 with graded structure  $28 + 64 + (A7+1) + 64 + 28$   
 The  $28 + 64 + 64 + 28$  part is already in the Lagrangian as creation / annihilation operators for gauge bosons and fermions.  
 The  $A7+1$  part is creation / annihilation operators for spacetime and equivalently  $A7 = SL(R,8)$  describes a Unimodular Gravity-like structure of Spacetime

## Octonionic to Quaternionic Transition at End of Inflation

To make contact with conventional physics see what happens at the End of Inflation when Octonionic Structure is broken to Quaternionic.

First the Base Manifold goes from Octonionic Lie Sphere Shilov Boundary  $RP1 \times S7$



to Quaternionic  $M4 \times CP2$  with  $M4 = \text{Lie Sphere Shilov Boundary } RP1 \times S3$   
and  $CP2 = SU(3) / SU(2) \times U(1)$



which causes the 8 algebraically independent Octonionic  $E8$  Lattices =  $D+8$  Lattices to collapse into one Quaternionic  $D+4$  Hyperdiamond Lattice =  $Z4$  Lattice the even vertices of which are a  $D4$  Lattice = Integral Quaternions

( Note that in the  $D+4$  Lattice each power-of-2 layer of norm  $2^n$  has 24 vertices whereas the  $E8$  Lattices has not that periodicity. )

so that the  $D8 / D4 \times D4$  term in the 8-dim Lagrangian goes away

Then the Octonionic base manifold splits into its Associative and Coassociative parts as Kaluza-Klein  $M4 \times CP2$  which geometrically produces the Higgs and the Second and Third Generations of fermions as shown on the following page:

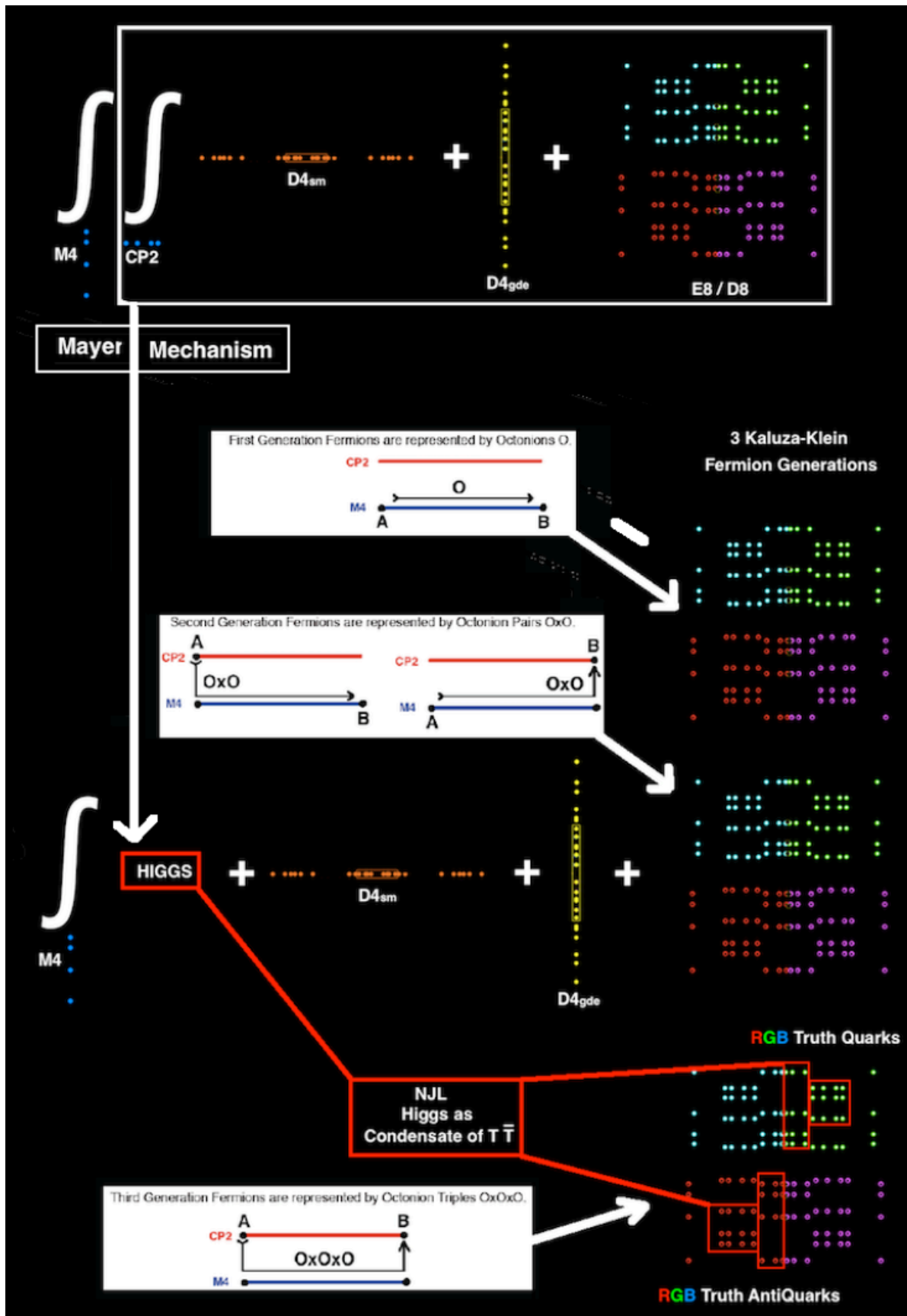

## Two D4 of D8 / D4xD4 M4 for Gravity+Dark Energy and CP2 for Standard Model

By 8-Periodicity for Real Clifford Algebras  $Cl(16) = \text{tensor product } Cl(8) \times Cl(8)$ .  
Each of the two  $Cl(8)$  contains one of the two D4 of D8 / D4xD4 in E8.

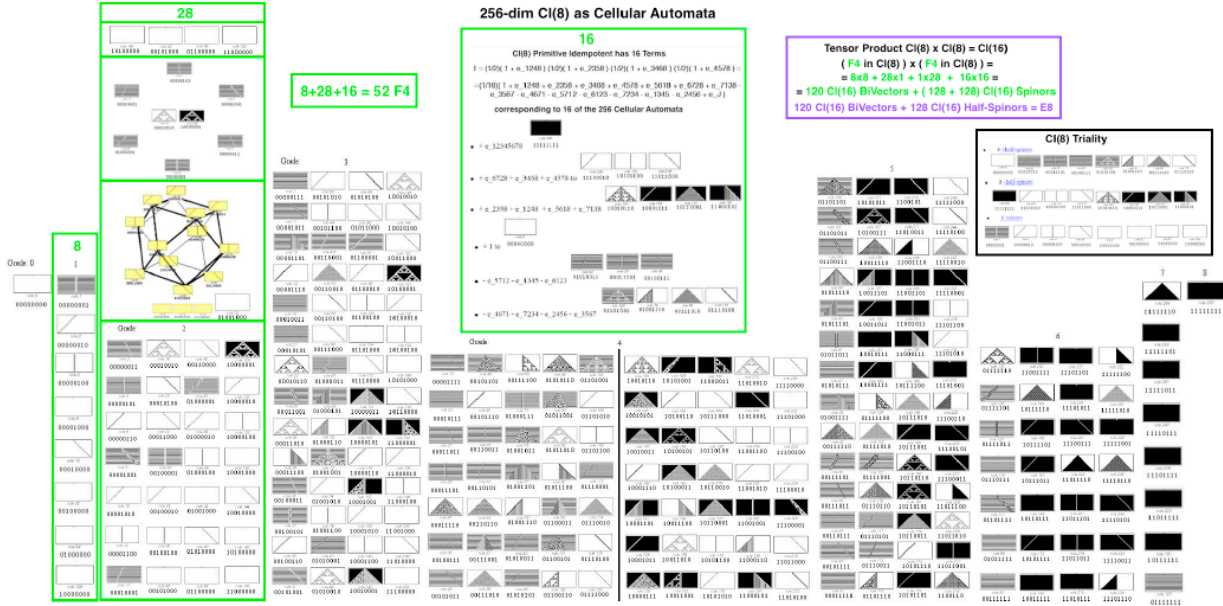

The 256 Elementary Cellular Automata correspond to the 256-dim  $Cl(8)$  Clifford Algebra with graded structure 1 8 28 56 (35+35=70) 56 28 8 1  
 The 28 BiVectors have clear physical interpretation as Ghosts plus Gauge Bosons of Gravity+Dark Energy (16) and of the Standard Model (12)

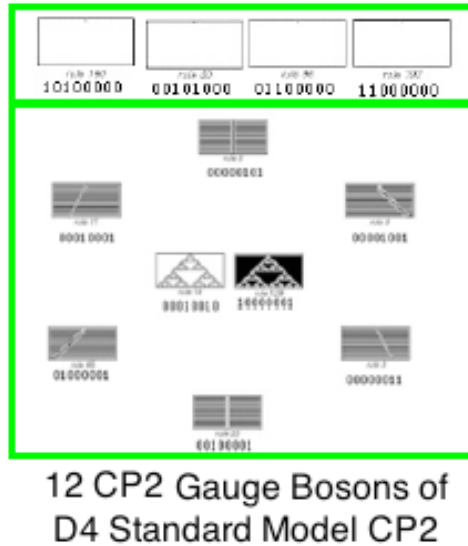
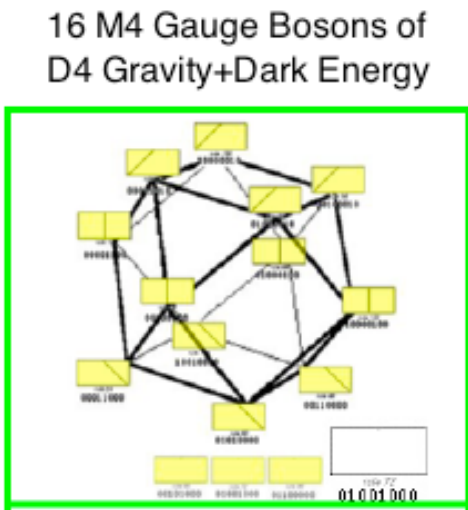

## D4 of M4 and Gravity+Dark Energy

Then one of the two D4 Spin(8) is forced to act primarily on the M4 with 16 of its 28 generators being gauge bosons of Gravity+Dark Energy and the other 12 playing reduced role of Standard Model ghosts

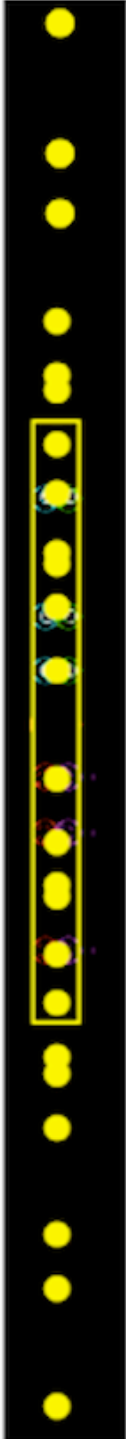

The 24 Yellow Root Vectors of the D4 of E8 Gravity + Standard Model Ghosts are on the Vertical Y-axis.

The 4 Cartan Subalgebra elements of D4 of E8 Gravity + Standard Model Ghosts correspond to half of the 8 Cartan Subalgebra elements of E8.

### In the Initial and Inflation Octonionic Phases of Our Universe

the 24+4 = 28 generators of D4 of E8 Gravity + Standard Model Ghosts act as a Spin(8) Gauge Group rotating all 8 dimensions of Octonionic Spacetime into each other.

### In the Post-Inflation Quaternionic Phase of Our Universe

8-dim Octonionic Spacetime splits into (4+4)-dim M4 x CP2 Kaluza-Klein Spacetime  
12 generators in the Yellow Box represent the 12 Root Vectors of the Conformal Gauge Group  $SU(2,2) = Spin(2,4)$  of Conformal Gravity + Dark Energy

The 4 Cartan Subalgebra elements of  $SU(2,2) \times U(1) = U(2,2)$  correspond to the 4 Cartan Subalgebra elements of D4 of E8 Gravity + Standard Model Ghosts and to the other half of the 8 Cartan Subalgebra elements of E8.

The other 24-12 = 12 Yellow Root Vectors represent Ghosts of 12D Standard Model whose Gauge Groups are  $SU(3) SU(2) U(1)$

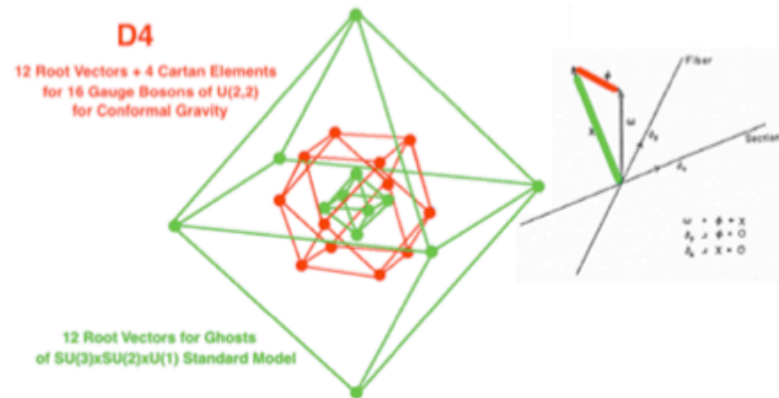

Gravity and Dark Energy come from D4 Conformal Subgroup  $SU(2,2) = Spin(2,4)$

$SU(2,2) = Spin(2,4)$  has 15 generators:

1 Dilation representing Higgs Ordinary Matter

4 Translations representing Primordial Black Hole Dark Matter

10 = 4 Special Conformal + 6 Lorentz representing Dark Energy  
(see Irving Ezra Segal, "Mathematical Cosmology and Extragalactic Astronomy" (Academic 1976))

The basic ratio Dark Energy : Dark Matter : Ordinary Matter = 10:4:1 = 0.67 : 0.27 : 0.06  
When the dynamics of our expanding universe are taken into account, the ratio is calculated to be **0.75 : 0.21 : 0.04**

### D4 of CP2 and Standard Model

The other D4 Spin(8) is forced to act primarily on the CP2 with 12 of its 28 generators being gauge bosons of Standard Model and the other 16 playing reduced role of Gravity+Dark Energy ghosts. Since CP2 = SU(3) / SU(2)xU(1) the Color SU(3) acts as a conventional gauge group but the ElectroWeak SU(2)xU(1) of CP2 acts as torsion which accounts for its chirality. The 24 Orange Root Vectors of the D4 of E8 Standard Model + Gravity Ghosts are on the Horizontal X-axis.

The 4 Cartan Subalgebra elements of D4 of E8 Standard Model + Gravity Ghosts correspond to half of the 8 Cartan Subalgebra elements of E8.

### In the Initial and Inflation Octonionic Phases of Our Universe

the 24+4 = 28 generators of D4 of E8 Standard Model + Gravity Ghosts act as a Spin(8) Gauge Group rotating all 8 Fermion types into each other.



### In the Post-Inflation Quaternionic Phase of Our Universe

8-dim Octonionic Spacetime splits into (4+4)-dim M4 x CP2 Kaluza-Klein Spacetime. 8 generators in the Orange Box represent the 8 Root Vectors of the Standard Model Gauge Groups SU(3) SU(2) U(1). Their 4 Cartan Subalgebra elements correspond to the 4 Cartan Subalgebra elements of D4 of E8 Standard Model + Gravity Ghosts and to half of the 8 Cartan Subalgebra elements of E8. The other 24-8 = 16 Orange Root Vectors represent Ghosts of 16D U(2,2) which contains the Conformal Group Spin(2,4) that produces Gravity + Dark Energy by the MacDowell-Mansouri mechanism. Standard Model Gauge groups come from CP2 = SU(3) / SU(2) x U(1) (as described by Batakis in Class. Quantum Grav. 3 (1986) L99-L105)

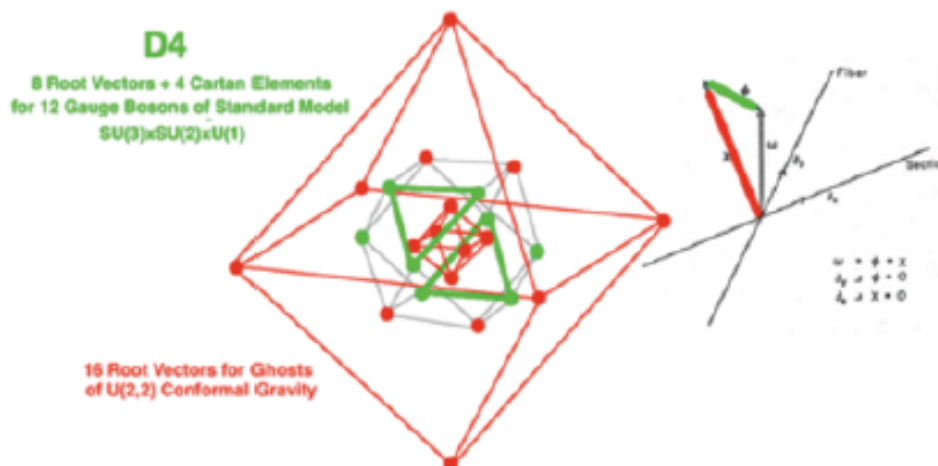

The 24-8 = 16 D4 of CP2 Root Vectors represent Ghosts of U(2,2) Conformal Gravity. Jean Thierry-Mieg in J. Math. Phys. 21 (1980) 2834-2838 said: "... The ghost and the gauge field: The single lines represent a local coordinate system of a principal fiber bundle of base space-time. The double lines are 1 forms. The connection of the principle bundle  $w$  is assumed to be vertical. Its contravariant components  $\Phi^I$  and  $X$  are recognized ... as the Yang-Mills gauge field and the Faddeev-Popov ghost form ..."



## Schwinger Sources and Calculations of Force Strengths, Particle Masses, etc

When a fermion particle/antiparticle appears in E8 spacetime it does not remain a single Planck-scale entity because **Tachyons create a cloud of particles/antiparticles**. The cloud is one Planck-scale Fundamental Fermion Valence Particle plus an effectively neutral cloud of particle/antiparticle pairs forming a Kerr-Newman black hole. That cloud constitutes the **Schwinger Source**. Its structure comes from the **24-dim Leech lattice part of the Monster Group which is**

**$2^{(1+24)}$  times the double cover of Co1, for a total order of about  $10^{26}$ .**

Since a Leech lattice is based on copies of an E8 lattice and since there are 7 distinct E8 integral domain lattices there are 7 (or 8 if you include a non-integral domain E8 lattice) distinct Leech lattices. The physical Leech lattice is a superposition of them, effectively adding a factor of 8 to the order.

The volume of the Kerr-Newman Cloud is on the order of  $10^{27}$  x Planck scale, so the Kerr-Newman Cloud **Source should contain about  $10^{27}$  particle/antiparticle pairs and its size should be about  $10^{(27/3)} \times 1.6 \times 10^{(-33)}$  cm = roughly  $10^{(-24)}$  cm.**

Fock "Fundamental of Quantum Mechanics" (1931) showed that it requires Linear Operators "... represented by a definite integral [of a]... kernel ... function ...".

Hua "Harmonic Analysis of Functions of Several Complex Variables in the Classical Domains" (1958) showed Kernel Functions for Complex Classical Domains.

Schwinger (1951 - see Schweber, PNAS 102, 7783-7788) "... introduced a description in terms of Green's functions, what Feynman had called propagators ... The Green's functions are vacuum expectation values of time-ordered Heisenberg operators, and the field theory can be defined non-perturbatively in terms of these functions ...[which]... gave deep structural insights into QFTs; in particular ... the structure of the Green's functions when their variables are analytically continued to complex values ...".

Wolf (J. Math. Mech 14 (1965) 1033-1047) showed that the Classical Domains (complete simply connected Riemannian symmetric spaces) representing 4-dim Spacetime with Quaternionic Structure are:

$S^1 \times S^1 \times S^1 \times S^1 = 4$  copies of **U(1)**

$S^2 \times S^2 = 2$  copies of **SU(2)**

$CP^2 =$  **SU(3)** / SU(2)xU(1)

$S^4 = Spin(5)$  / Spin(4) = Euclidean version of **Spin(2,3)** / Spin(1,3)

**Armand Wyler** (1971 - C. R. Acad. Sc. Paris, t. 271, 186-188) showed how to use **Green's Functions = Kernel Functions** of Classical Domain structures characterizing **Sources = Leptons, Quarks, and Gauge Bosons, to calculate Particle Masses and Force Strengths**

Cl(16) Physics constructs the **Lagrangian** integral such that the **mass m emerges as the integral over the Schwinger Source spacetime region** of its Kerr-Newman cloud of virtual particle/antiparticle pairs plus the Valence Fermion so that the volume of the Schwinger Source fermion defines its mass, which, being dressed with the particle/antiparticle pair cloud, gives **quark mass as constituent mass**.

**Armand Wyler used Harmonic Geometry to calculate:**

**Fermion masses** as a product of four factors:

$$V(Q\text{fermion}) \times N(\text{Graviton}) \times N(\text{octonion}) \times \text{Sym}$$

$V(Q\text{fermion})$  is the volume of the part of the half-spinor fermion particle manifold  $S^7 \times RP^1$  related to the fermion particle by photon, weak boson, or gluon interactions.

$N(\text{Graviton})$  is the number of types of Spin(0,5) graviton related to the fermion.

$N(\text{octonion})$  is an octonion number factor relating up-type quark masses to down-type quark masses in each generation.

Sym is an internal symmetry factor, relating 2nd and 3rd generation massive leptons to first generation fermions. It is not used in first-generation calculations.

**Force Strengths** are made up of two parts:

- the relevant spacetime manifold of gauge group global action
- the U(1) photon sees 4-dim spacetime as  $T^4 = S^1 \times S^1 \times S^1 \times S^1$
- the SU(2) weak boson sees 4-dim spacetime as  $S^2 \times S^2$
- the SU(3) weak boson sees 4-dim spacetime as CP2
- the Spin(5) of gravity sees 4-dim spacetime as  $S^4$

and

the volume of the Shilov boundary corresponding to the symmetric space with local symmetry of the gauge boson. The nontrivial Shilov boundaries are:

- for SU(2) Shilov =  $RP^1 \times S^2$
- for SU(3) Shilov =  $S^5$
- for Spin(5) Shilov =  $RP^1 \times S^4$

Schwinger Sources as described above are continuous manifold structures of Bounded Complex Domains and their Shilov Boundaries but the E8-Cl(16) model at the Planck Scale has spacetime condensing out of Clifford structures forming a Lorentz Leech lattice underlying 26-dim String Theory of World-Lines with  $8 + 8 + 8 = 24$ -dim of fermion particles and antiparticles and of spacetime.

**The automorphism group of a single 26-dim String Theory cell modulo the Leech lattice is the Monster Group of order about  $8 \times 10^{53}$ .**

The problem of the determination of the quark masses is not trivial. We can define as a “current” quark mass the mass entering in the Lagrangian (or Hamiltonian) representation of a hadron; this comes out to be of the order of some  $\text{MeV}/c^2$  for  $u, d$  quarks, and  $\sim 0.2 \text{GeV}/c^2$  for  $s$  quarks. However, the strong field surrounds the quarks in such a way that they acquire a “constituent” (effective) mass including the equivalent of the color field; this comes out to be of the order of some  $300 \text{MeV}/c^2$  for  $u, d$  quarks, and  $\sim 0.5 \text{GeV}/c^2$  for  $s$  quarks. Current quark masses are almost the same as constituent quark mass for heavy quarks. Alessandro De Angelis · Mário Pimenta

Introduction to Particle and Astroparticle Physics Second Edition

Wyler Force Strength and Mass Calculation  
 Details are in viXra 1810.0365

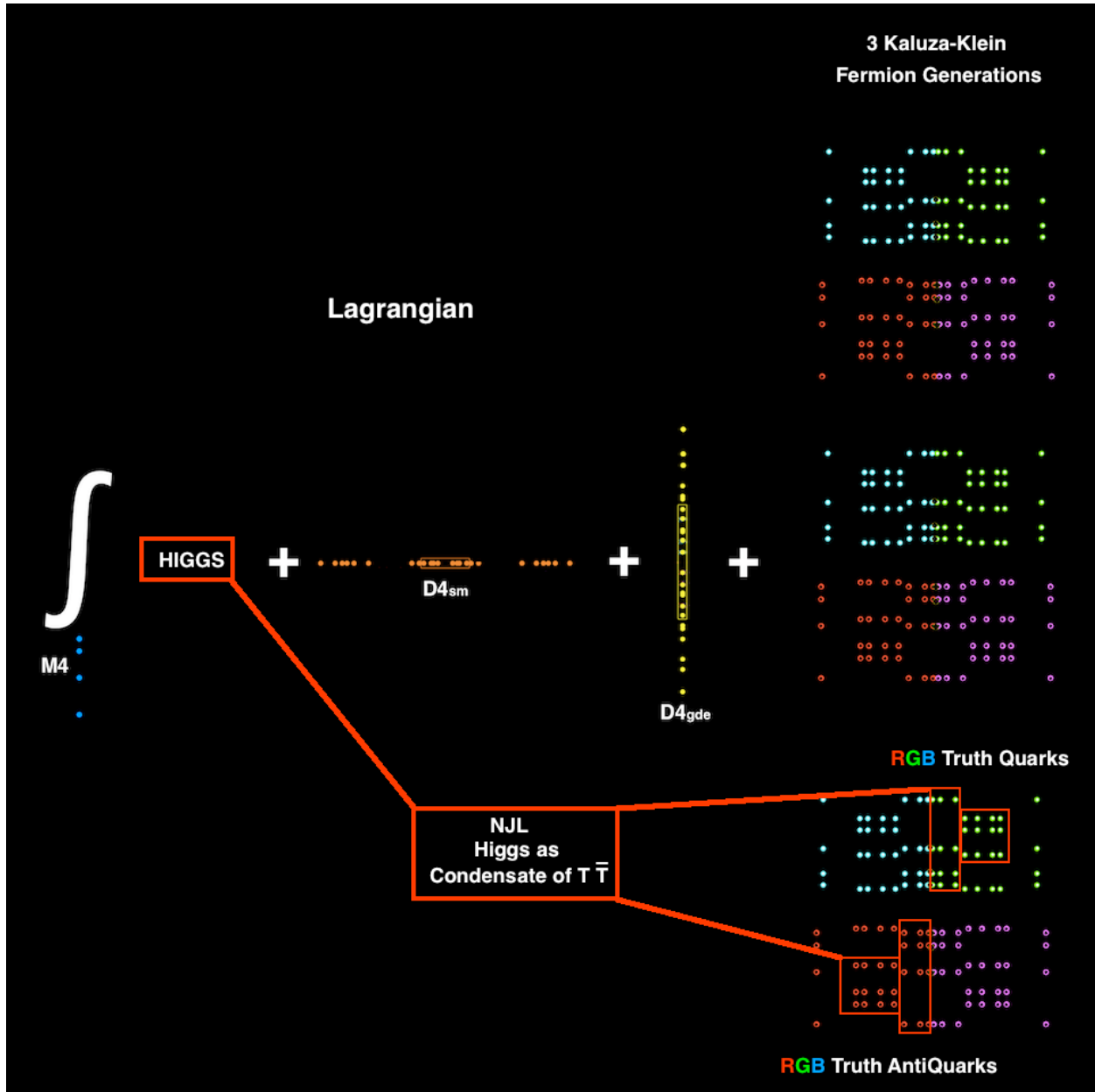

The E8 model constructs the Lagrangian integral such that the mass  $m$  emerges as the integral over the Schwinger Source spacetime region of its Kerr-Newman cloud of virtual particle/antiparticle pairs plus the valence fermion so that the volume of the Schwinger Source fermion defines its mass, which, being dressed with the particle/antiparticle pair cloud, gives quark mass as constituent mass.

Fermion Schwinger Sources correspond to the Lie Sphere Symmetric space  
 $Spin(10) / Spin(8) \times U(1)$

with Bounded Complex Domain D8 of type IV8 and Shilov Boundary  $Q8 = RP^1 \times S^7$  which has local symmetry of the  $Spin(8)$  gauge group from which the first generation spinor fermions are formed as **+half-spinor** and **-half-spinor** spaces

For the Gauge Gravity and Standard Model Gauge Bosons the process of breaking Octonionic 8-dim SpaceTime down to Quaternionic (4+4)-dim M4 x CP2 Kaluza-Klein creates differences in the way gauge bosons "see" 4-dim Physical SpaceTime. There are 4 equivalence classes of 4-dimensional Riemannian Symmetric Spaces with Quaternionic structure consistent with 4-dim Physical SpaceTime:

$S_4$  = 4-sphere = Spin(5) / Spin(4) where Spin(5) = Schwinger-Euclidean version of the Anti-DeSitter subgroup of the Conformal Group that gives [MacDowell-Mansouri Gravity](#)

$CP_2$  = complex projective 2-space = SU(3) / U(2) with [the SU\(3\) of the Color Force](#)

$S_2 \times S_2$  = SU(2)/U(1) x SU(2)/U(1) with two copies of [the SU\(2\) of the Weak Force](#)

$S_1 \times S_1 \times S_1 \times S_1$  = U(1) x U(1) x U(1) x U(1) = 4 copies of [the U\(1\) of the EM Photon](#) ( 1 copy for each of the 4 covariant components of the Photon )

The Gravity Gauge Bosons (Schwinger-Euclidean versions) live in a Spin(5) subalgebra of the Spin(6) Conformal subalgebra of D4 = Spin(8). They "see" M4 Physical spacetime as the 4-sphere S4 so that their part of the Physical Lagrangian is

$\int$  Gravity Gauge Boson Term

S4 .

an integral over SpaceTime S4.

The Schwinger Sources for GRb bosons are the Complex Bounded Domains and Shilov Boundaries for Spin(5) MacDowell-Mansouri Gravity bosons.

However, due to Stabilization of Condensate SpaceTime

by virtual Planck Mass Gravitational Black Holes,

for Gravity, the effective force strength that we see in our experiments

is not just composed of the S4 volume and the Spin(5) Schwinger Source volume, but is suppressed by the square of the Planck Mass.

The unsuppressed Gravity force strength is the Geometric Part of the force strength.

The Standard Model SU(3) Color Force bosons live in a SU(3) subalgebra of the SU(4) subalgebra of D4 = Spin(8). They "see" M4 Physical spacetime as the complex projective plane CP2 so that their part of the Physical Lagrangian is

$$\int_{\text{CP}^2} \text{SU(3) Color Force Gauge Boson Term}$$

CP2 .  
an integral over SpaceTime CP2.

The Schwinger Sources for SU(3) bosons are the Complex Bounded Domains and Shilov Boundaries for SU(3) Color Force bosons. The Color Force Strength is given by the SpaceTime CP2 volume and the SU(3) Schwinger Source volume.

Note that since the Schwinger Source volume is dressed with the particle/antiparticle pair cloud, the calculated force strength is for the characteristic energy level of the Color Force (about 245 MeV).

The Standard Model SU(2) Weak Force bosons live in a SU(2) subalgebra of the U(2) local group of CP2 = SU(3) / U(2). They "see" M4 Physical spacetime as two 2-spheres S2 x S2 so that their part of the Physical Lagrangian is

$$\int_{\text{S}^2 \times \text{S}^2} \text{SU(2) Weak Force Gauge Boson Term}$$

S2xS2 .  
an integral over SpaceTime S2xS2.

The Schwinger Sources for SU(2) bosons are the Complex Bounded Domains and Shilov Boundaries for SU(2) Weak Force bosons. However, due to the action of the Higgs mechanism, for the Weak Force, the effective force strength that we see in our experiments is not just composed of the S2xS2 volume and the SU(2) Schwinger Source volume, but is suppressed by the square of the Weak Boson masses.

The unsuppressed Weak Force strength is the Geometric Part of the force strength.

The Standard Model U(1) Electromagnetic Force bosons (photons) live in a U(1) subalgebra of the U(2) local group of CP2 = SU(3) / U(2). They "see" M4 Physical spacetime as four 1-sphere circles S1xS1xS1xS1 = T4 (T4 = 4-torus) so that their part of the Physical Lagrangian is

$$\int_{\text{T}^4} \text{(U(1) Electromagnetism Gauge Boson Term)}$$

T4 .  
an integral over SpaceTime T4.

The Schwinger Sources for U(1) photons are the Complex Bounded Domains and Shilov Boundaries for U(1) photons. The Electromagnetic Force Strength is given by the SpaceTime T4 volume and the U(1) Schwinger Source volume.

## Fermion Mass Calculations

In Cl(16) Physics, the first generation spinor fermions are seen as +half-spinor and -half-spinor spaces of  $Cl(1,7) = Cl(8)$ .

Due to Triality, Spin(8) can act on those 8-dimensional half-spinor spaces similarly to the way it acts on 8-dimensional vector spacetime.

Take the spinor fermion volume to be the Shilov boundary corresponding to the same symmetric space on which Spin(8) acts as a local gauge group that is used to construct 8-dimensional vector spacetime:

the symmetric space  $Spin(10) / Spin(8) \times U(1)$   
corresponding to a bounded domain of type IV8  
whose Shilov boundary is  $RP^1 \times S^7$

Since all first generation fermions see the spacetime over which the integral is taken in the same way ( unlike what happens for the force strength calculation ), the only geometric volume factor relevant for calculating first generation fermion mass ratios is in the spinor fermion volume term.

Cl(16) Physics Fermions correspond to Schwinger Sources, so the quark mass in Cl(16) Physics is a constituent mass.

Fermion masses are calculated as a product of four factors:

$$V(Q\text{fermion}) \times N(\text{Graviton}) \times N(\text{octonion}) \times \text{Sym}$$

$V(Q\text{fermion})$  is the volume of the part of the half-spinor fermion particle manifold  $S^7 \times RP^1$  related to the fermion particle by photon, weak boson, or gluon interactions.

$N(\text{Graviton})$  is the number of types of Spin(0,5) graviton related to the fermion. The 10 gravitons correspond to the 10 infinitesimal generators of  $Spin(0,5) = Sp(2)$ . 2 of them are in the Cartan subalgebra.

6 of them carry color charge, and therefore correspond to quarks.

The remaining 2 carry no color charge, but may carry electric charge and so may be considered as corresponding to electrons.

One graviton takes the electron into itself, and the other can only take the first generation electron into the massless electron neutrino. Therefore only one graviton should correspond to the mass of the first-generation electron. The graviton number ratio of the down quark to the first-generation electron is therefore  $6/1 = 6$ .

$N(\text{octonion})$  is an octonion number factor relating up-type quark masses to down-type quark masses in each generation.

Sym is an internal symmetry factor, relating 2nd and 3rd generation massive leptons to first generation fermions. It is not used in first-generation calculations.

The first generation down quark constituent mass : electron mass ratio is:

The electron, E, can only be taken into the tree-level-massless neutrino, 1, by photon, weak boson, and gluon interactions.

The electron and neutrino, or their antiparticles, cannot be combined to produce any of the massive up or down quarks.

The neutrino, being massless at tree level, does not add anything to the mass formula for the electron.

Since the electron cannot be related to any other massive Dirac fermion, its volume  $V(Q_{\text{electron}})$  is taken to be 1.

Next consider a red down quark i.

By gluon interactions, i can be taken into j and k, the blue and green down quarks.

By also using weak boson interactions,

it can also be taken into l, j, and k, the red, blue, and green up quarks.

Given the up and down quarks, pions can be formed from quark-antiquark pairs, and the pions can decay to produce electrons and neutrinos.

Therefore the red down quark (similarly, any down quark)

is related to all parts of  $S^7 \times RP^1$ ,

the compact manifold corresponding to  $\{ 1, i, j, k, E, l, j, k \}$

and therefore

a down quark should have

a spinor manifold volume factor  $V(Q_{\text{down quark}})$  of the volume of  $S^7 \times RP^1$ .

The ratio of the down quark spinor manifold volume factor

to the electron spinor manifold volume factor is

$$V(Q_{\text{down quark}}) / V(Q_{\text{electron}}) = V(S^7 \times RP^1) / 1 = \pi^5 / 3.$$

Since the first generation graviton factor is 6,

$$m_d / m_e = 6 V(S^7 \times RP^1) = 2 \pi^5 = 612.03937$$

As the up quarks correspond to l, j, and k, which are the octonion transforms under E of i, j, and k of the down quarks, the up quarks and down quarks have the same constituent mass

$$m_u = m_d.$$

Antiparticles have the same mass as the corresponding particles.

Since the model only gives ratios of masses,

the mass scale is fixed so that the electron mass  $m_e = 0.5110 \text{ MeV}$ .

Then, the constituent mass of the down quark is  $m_d = 312.75 \text{ MeV}$ ,

and the constituent mass for the up quark is  $m_u = 312.75 \text{ MeV}$ .

**Further Calculations and Details are in viXra 1810.0365**

## Results of E8 Physics Calculations:

Here is a summary of E8 Physics model calculation results. Since ratios are calculated, values for one particle mass and one force strength are assumed. Quark masses are constituent masses. Most of the calculations are tree-level, so more detailed calculations might be even closer to observations.

Fermions as Schwinger Sources have geometry of Complex Bounded Domains with Kerr-Newman Black Hole structure size about  $10^{(-24)}$  cm.

( for calculation details see viXra 1804.0121 )

Dark Energy : Dark Matter : Ordinary Matter = 0.75 : 0.21 : 0.04

Particle/Force	Tree-Level	Higher-Order
e-neutrino	0	0 for nu_1
mu-neutrino	0	$9 \times 10^{(-3)}$ eV for nu_2
tau-neutrino	0	$5.4 \times 10^{(-2)}$ eV for nu_3
electron	0.5110 MeV	
down quark	312.8 MeV	charged pion = 139 MeV
up quark	312.8 MeV	proton = 938.25 MeV
		neutron - proton = 1.1 MeV
muon	104.8 MeV	106.2 MeV
strange quark	625 MeV	
charm quark	2090 MeV	
tauon	1.88 GeV	
beauty quark	5.63 GeV	
truth quark (low state)	130 GeV	(middle state) 174 GeV (high state) 218 GeV
W+	80.326 GeV	
W-	80.326 GeV	
W0	98.379 GeV	Z0 = 91.862 GeV
Mplanck	$1.217 \times 10^{19}$ GeV	
Higgs VEV (assumed)	252.5 GeV	
Higgs (low state)	126 GeV	(middle state) 182 GeV (high state) 239 GeV
Gravity Gg (assumed)	1	
(Gg)(Mproton <sup>2</sup> / Mplanck <sup>2</sup> )		$5 \times 10^{(-39)}$
EM fine structure	1/137.03608	
Weak Gw	0.2535	
Gw(Mproton <sup>2</sup> / (Mw+ <sup>2</sup> + Mw- <sup>2</sup> + Mz0 <sup>2</sup> ))		$1.05 \times 10^{(-5)}$
Color Force at 0.245 GeV	0.6286	0.106 at 91 GeV

Kobayashi-Maskawa parameters for W+ and W- processes are:

	d	s	b
u	0.975	0.222	0.00249 -0.00388i
c	-0.222 -0.000161i	0.974 -0.0000365i	0.0423
t	0.00698 -0.00378i	-0.0418 -0.00086i	0.999

The phase angle d13 is taken to be 1 radian.

which includes calculations from



a Nambu-Jona-Lasinio System of Higgs and Truth Quarks that has Higgs as Truth Quark-AntiQuark Condensate and 3 mass states:

Higgs at 125 GeV and Truth Quark at 130 GeV  
 Higgs at 200 GeV and Truth Quark at 174 GeV  
 Higgs at 250 GeV and Truth Quark at 220 GeV

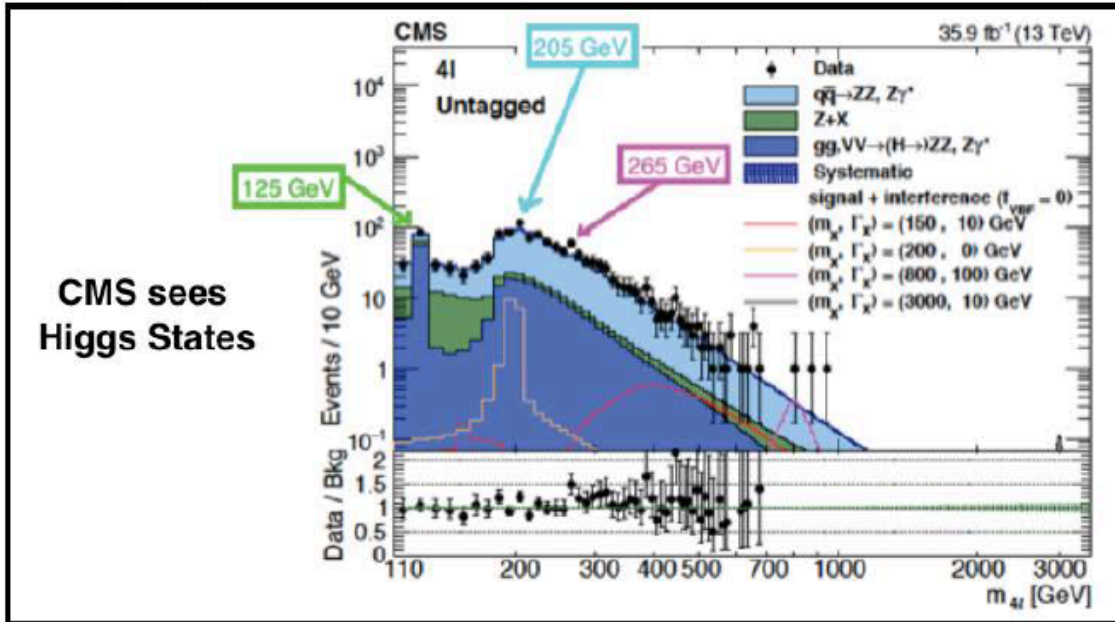
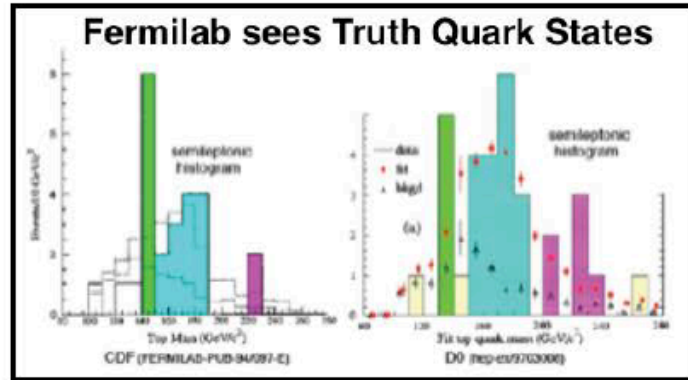
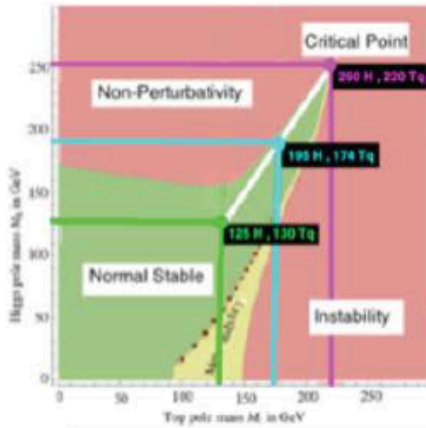

## Algebraic Quantum Field Theory

26D String Theory has a Real Clifford Algebra  $Cl(1,25)$  constructed from

$Cl(16) = Cl(8) \times Cl(8) \rightarrow Cl(8) \times Cl(8) \times Cl(8) = Cl(24)$   
to get to the Leech Lattice 24-dim Vector Space

Conformal Structure of  $2 \times 2$  matrices with entries in  $Cl(24)$   
(Porteous, Clifford Algebras and the Classical Groups and  
Lounesto and Porteous, Lectures on Clifford (Geometric) Algebras and Applications )  
gives  $M(2, Cl(24)) = Cl(1,25)$  with Lorentz Leech Lattice Vector Space.

Since all the matrix entries are tensor product of 3 copies of  $Cl(0,8)$   
8-Periodicity allows formation of the tensor products of copies of  $Cl(1,25)$

$$Cl(1,25) \times \dots (N \text{ times tensor product}) \dots \times Cl(1,25)$$

For  $N = 2^8 = 256$  the copies of  $Cl(1,25)$  are on the 256 vertices  
of the 8-dim HyperCube

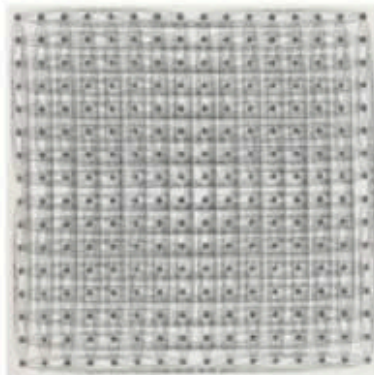

For  $N = 2^{16} = 65,536$  the copies of  $Cl(1,25)$  fill in the 8-dim HyperCube  
William Gilbert's web page says: "... The n-bit reflected binary [Gray code](#)  
will describe a path on the edges of an n-dimensional cube that can be  
used as the initial stage of a Hilbert curve that will fill an n-dim... cube. ...".

As  $N$  grows, the copies of  $Cl(1,25)$  continue to fill the 8-dim HyperCube of  
 $E_8$  SpaceTime using higher Hilbert curve stages from the 8-bit reflected  
binary Gray code subdividing the initial 8-dim HyperCube into more and  
more sub-HyperCubes.

If edges of sub-HyperCubes, equal to the distance between adjacent copies of  $Cl(1,25)$ , remain constantly at the Planck Length, then the full 8-dim HyperCube of our Universe expands as  $N$  grows to  $2^{16}$  and beyond similarly to the way shown by this 3-HyperCube example for  $N = 2^3, 4^3, 8^3$  from William Gilbert's web page:

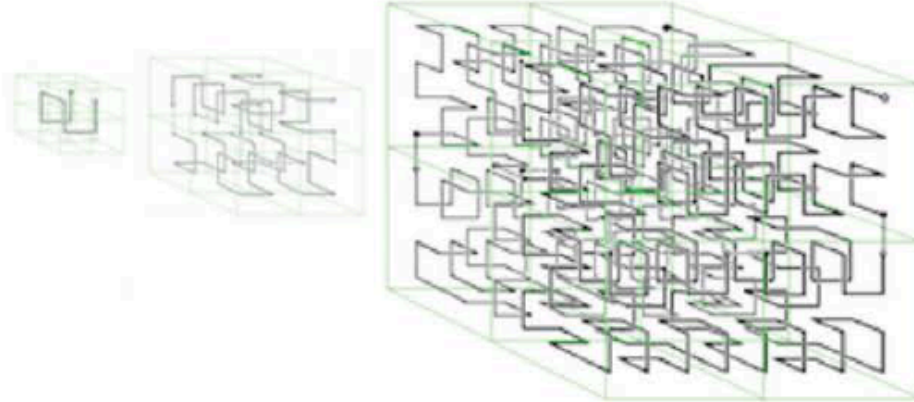

**Completion of Union of All Tensor Products of  $Cl(1,25)$  =  
= hyperfinite AQFT = Algebraic Quantum Field Theory =  
= the Third Grothendieck Universe**

The AQFT contains a copy of  $E_8$  within  $Cl(16)$  within each copy of  $Cl(1,25)$

**The  $E_8$  is a Recipe for a Realistic Physics Lagrangian  
so the AQFT has a natural realistic Lagrangian structure.**

The Vector Space of  $Cl(1,25)$  is the Spacetime of a 26D String Theory  
in which Strings are World-Lines of Particles  
and

**the Massless Symmetric Spin 2 State is the Carrier  
of the Bohm Quantum Potential with Sarfatti Back-Reaction**

The  $Cl(1,25)$  AQFT being the completion of the union of all tensor products of  $Cl(1,25)$   
it is the **Real Clifford Algebra (8-Periodicity) analog**  
of the completion of the union of all tensor products of the Complex Clifford Algebra  
(2-Periodicity)  $Cl(2;C)$  of  $2 \times 2$  Complex Matrices =  $M_2(C)$  of Spinor Fock Space that  
is the **Hyperfinite  $II_1$  von Neumann factor algebra.**

## Bohm Quantum Potential and Quantum Consciousness

Strings = World Lines and World Lines are past and future histories of particles, so spin-2 Bohmions carry Bohm Quantum Potential with Back-Reaction of Sarfatti's extension of the Sutherland Lagrangian for the Bohm Potential

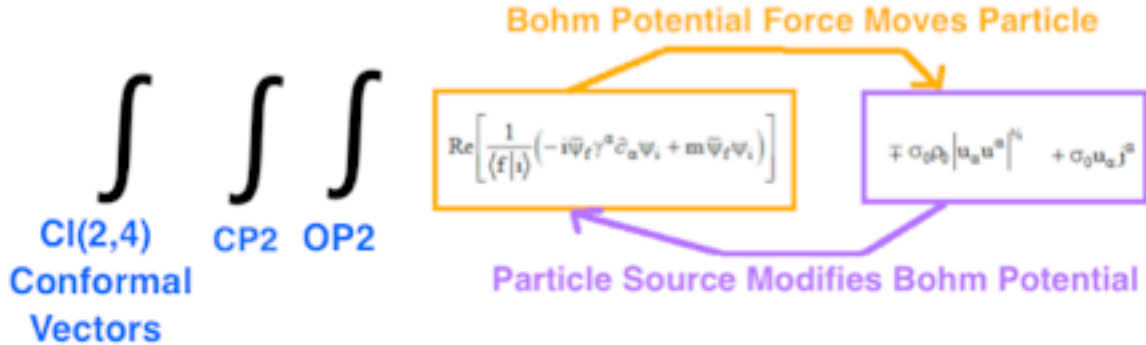

where a, b and M4 form CI(2,4) vectors and M4 x CP2 = Kaluza-Klein Spacetime and CI(8) half-Spinors S+ and S- form OP2 so that  
 26D = 16D orbifolded fermions + 10D and 10D = 6D Conformal Space + 4D CP2

Similarity of the spin 2 Bohmion to the spin 2 Graviton accounts for the Bohmion's ability to support Penrose Consciousness with Superposition Separation Energy Difference  $G m^2 / a$  where,  
 for a Human Brain, m = mass of electron and a = 1 nanometer in Tubulin Dimer

**“... Bohm's Quantum Potential can be viewed as an internal energy of a quantum system ...”**

according to Dennis, de Gosson, and Hiley ( arXiv 1412.5133 )

and

**Bohm Quantum Potential inherits Sarfatti Back-Reaction from its spin-2 structure similar to General Relativity**

Peter R. Holland says in "The Quantum Theory of Motion" (Cambridge 1993):

"... the total force ... from the quantum potential ... does not ... fall off with distance ... because ... the quantum potential ... depends on the form of ...[the quantum state]... rather than ... its ... magnitude ...".

Further,

each cell of E8 Lagrangian Spacetime corresponds to 65,536-dim Cl(16)  
which contains 248-dim E8 = 120-dim D8 bivectors +128-dim D8 half-spinors  
and

Human Brain Microtubules 40 microns long have 65,536 Tubulin Dimers



( image adapted from 12biophys.blogspot.com Lecture 11 )

So

Brain Microtubules can have Bohm Quantum Resonance with Cl(16) Spacetime cells  
and at any and all Times

the State of Consciousness of a Human is in exact resonant correspondence with  
a subset of the cells of E8 Classical Lagrangian Spacetime

Therefore

E8 Lagrangian Spacetime (as a Nambu-Jona-Lasinio Condensate)  
is effectively the Spirit World

in which the Human States of Consciousness = Souls exist.

After the death of the Human Physical Body the Spirit World interactions with its Soul  
are no longer constrained by Physical World interactions with its Body

so

**the Spirit World can harmonize the individual Soul  
with the collective Universal Soul.**

